

FLEXISTEM Small Channel Cleaners

Code No	Description	Length (ft.)	Dia. (mm)	Price
FLEX001	Soft Cleaner - Roll	40.0	3.0	\$10.50
FLEX002	Super Bristle - Roll	40.0	3.0	\$12.00
FLEX003	Double Clean Stem - 100 each	0.5	3.0	\$31.10
FLEX033	Polypropylene Flexistem - 50 each	1.0	3.0	\$20.75
FLEX004	Fleece Stem - 50 each	1.0	9.0	\$28.50
FLEX005	Fleece Stem - 50 each	1.0	12.0	\$31.10
FLEX006	Bristle Stem - 20 each	1.0	15.0	\$20.75
FLEX007	Bristle Stem - Roll	20.0	15.0	\$18.65
FLEX007A	Wavy Stem - 20Ft Roll (3 mm - 15mm dia.)			\$18.65
FLEX008	Dispenser and 1 pack of each			\$309.85
FLEX009	Complete Refill Pack			\$155.45

FLEXISTEM Ultra Channel Cleaners

Code No	Description	Length (in.)	Dia. (mm)	Price
FLEX021	Super Fine - Roll	6.0	3.0	\$16.60
FLEX022	Medium Fine - Roll	6.0	6.0	\$17.65
FLEX023	Super Brush - Roll	6.0	3.0	\$19.45
FLEX024	Medium Brush - Roll	6.0	6.0	\$20.75
FLEX025	Dispenser and 1 pack of each			\$206.25
FLEX026	Complete Refill Pack			\$72.55

ProSys™ Instrument Cleaning Brushes

Code No	Description	Overall Length (cm)	Diameter (mm)	Brush Part (mm)	Qty	Price
CCBRK-1	Complete Brush Kit with Storage Rack				1	\$102.60
RPCBRK-1	Complete Brush Kit w/o Storage Rack				1	\$72.50
4030	Standard Tube Brush	6	6.0	51.0	1	\$1.65
4031	Standard Tube Brush	6	10.0	51.0	1	\$1.90
52003-35	For Verres Needles	20	1.4	25.0	12	\$61.95
4032	Standard Tube Brush	22	13.0	76.0	1	\$2.10
4033	Standard Tube Brush	22	16.0	76.0	1	\$2.20
4034	Standard Tube Brush	22	19.0	76.0	1	\$2.00
TR350109	Special Tube Brush	30	2.0	20.0	3	\$9.70
TR350232	Special Tube Brush	30	3.0	20.0	3	\$9.70
TR350233	Special Tube Brush	30	4.0	20.0	3	\$9.70
TR350354	Special Tube Brush	30	5.0	20.0	3	\$9.70

Code No	Description	Overall Length (cm)	Diameter (mm)	Brush Part (mm)	Qty	Price
TR350429	Special Tube Brush	30	6.0	20.0	3	\$9.70
52003-25	For 8mm Trocar Sleeves	31	8.0	76.0	12	\$55.45
10-1660	Special Tube Brush	31	3.2	57.0	3	\$55.20
52003-21-5	For 3mm Trocar & 6mm Biopsy Tongs	30	3.0	57.0	12	\$55.45
52003-27	For 10mm Trocar Sleeves	31	10.0	76.0	12	\$55.45
4035	Standard Tube Brush	32	25.0	102.0	1	\$3.35
4041	Standard Tube Brush	33	11.0	89.0	3	\$10.55
4036	Standard Tube Brush	33	32.0	102.0	1	\$3.40
4037	Standard Tube Brush	33	38.0	102.0	1	\$3.90
4038	Standard Tube Brush	33	44.0	102.0	1	\$5.40
4039	Standard Tube Brush	33	51.0	102.0	1	\$5.65
10-1664	Special Tube Brush	38	9.5	64.0	3	\$73.50
10-1668	Special Tube Brush	38	19.0	89.0	3	\$57.75
24-1-035	Cleaning Brush, White Nylon, 15 FR	41	4.8	64.0	6	\$52.50
24-1-040	Cleaning Brush, White Nylon, 18 FR	41	6.0	64.0	6	\$52.50
24-1-055	Cleaning Brush, White Nylon, 45 FR	41	15.0	64.0	6	\$52.50
24-1-045	Cleaning Brush, White Nylon, 33 FR	41	11.0	64.0	6	\$52.50
24-1-050	Cleaning Brush, White Nylon, 36 FR	41	12.0	64.0	6	\$52.50
24-1-060	Cleaning Brush, White Nylon, 60 FR	41	20.0	64.0	6	\$52.50
24-1-007	Cleaning Brush, White Nylon, 3 FR	46	0.8	13.0	6	\$52.50
24-1-010	Cleaning Brush, White Nylon, 4.5 FR	46	1.5	13.0	6	\$52.50
24-1-015	Cleaning Brush, White Nylon, 5 FR	46	2.0	13.0	6	\$52.50
24-1-020	Cleaning Brush, White Nylon, 6.6 FR	46	2.3	13.0	6	\$52.50
24-1-025	Cleaning Brush, White Nylon, 8 FR	46	2.5	25.0	6	\$52.50
24-1-030	Cleaning Brush, White Nylon, 9 FR	46	3.3	25.0	6	\$52.50
52003-21	For 3mm Trocar & 6mm Biopsy Tongs	48	3.0	76.0	12	\$55.45
52003-23	For 6mm Trocar Sleeves	48	6.0	76.0	12	\$55.45
52003-33	For 3mm Biopsy Tongs	48	3.0	76.0	12	\$55.45
TR03020	Special Tube Brush	51	0.7	13.0	3	\$17.60
130-14	Special Tube Brush	53	6.4	102.0	3	\$14.85
130-38	Special Tube Brush	53	9.5	102.0	3	\$14.85
24-1-041	Cleaning Brush, White Nylon, 18 FR	61	6.0	64.0	6	\$52.50
24-1-046	Cleaning Brush, White Nylon, 33 FR	61	11.0	64.0	6	\$52.50
4042	Standard Tube Brush	61	13.0	76.0	3	\$13.55
TR360231	Special Tube Brush	61	2.5	76.0	3	\$11.20
TR150221	Special Tube Brush	61	5.0	76.0	3	\$8.25
TR150483	Special Tube Brush	61	7.0	76.0	3	\$8.25
TR160617	Special Tube Brush	61	10.0	76.0	3	\$8.25

ProSys™ Instrument Cleaning Brushes

Code No	Description	Overall Length (cm)	Diameter (mm)	Brush Part (mm)	Qty	Price
86-0340-1206	Shaver Brush	15	12.7	45.0	1	\$8.85
86-1234-0006	Shaver Brush	15	19.1	57.0	1	\$7.55
86-0516-1212	Shaver Brush	33	8.9	76.0	1	\$6.75
86-00004-0009	Shaver Brush	23	7.1	29.0	1	\$8.85
86-021201234	Shaver Brush	15	12.7	57.0	1	\$8.85
RB181603	Reamer Brush	46	16.0	76.0	1	\$17.10
RB300105	Reamer Brush	76	5.0	51.0	1	\$17.10
RB310306	Reamer Brush	79	6.0	76.0	1	\$20.70
RB310307	Reamer Brush	79	7.0	76.0	1	\$20.70
3770	Trumpet Valve Brush	31	1.0	7.0	1	\$2.35
3770-S	Trumpet Valve Brush - Sterile	31	1.0	7.0	25	\$158.75



Toothbrush Style Brushes

Code No	Description	Length	Width	Trim	QTY	Price
200599	Double Ended Brass Brush	18	13.0	13.0	1	\$4.40
200499	Double Brush/Stainless	18	13.0	13.0	1	\$5.20
200399-S	Double Ended Brush - PKG Sterile	18	13.0	13.0	1	\$124.35
200399	Double Brush/Nylon	18	13.0	13.0	1	\$4.40
C-1002	brass (pack of 3 brushes)	18	38.0	13.0	3	\$18.40
3182-P	stainless	20	38.0	13.0	1	\$1.30
3181-P	nylon	20	38.0	13.0	1	\$1.30
221 SN	nylon & stainless	120	38.0	13.0	1	\$5.10

Block Style Brushes



Code No	Description	Length	Width	Trim	Price
869903N	Nylon	2.50	3.00	1.25	\$6.90
3090	Stainless	10.00	1.00	1.25	\$9.15
4007	Nylon	10.00	1.00	1.25	\$8.55
GDS-1	Nylon, w/Surgical Nail Brush	4.00	1.60	0.50	\$1.80
GDS-2	Nylon	4.10	1.60	0.50	\$1.85



Bipolar Forceps Cleaner

Code No	Description	Price
DIA001	Bipolar Forcep Cleaner Set - Stainless	\$29.55

LTA Instrument Cleaning Brushes

Code No	Description	Overall Length (cm)	Diameter (mm)	Brush Part (mm)	Qty	Price
570	Precison Extn Cleaning Brush	16		32.0	1	\$47.38
540	SPI Brush w/ Ridgid Bristles	17		45.0	1	\$47.38
560	Precison Extn Brush w/ Rigid Fibers	17		43.0	1	\$47.38
510	External Brush w/ Rigid Bristles	22		76.0	1	\$77.18
510C	External Brush w/ Rigid Bristles	22		76.0	1	\$77.18
520	External Brush w/ Med Bristles	22		76.0	1	\$77.18
610-50-SP	G-Flex Wand, 3-4 MM	50	4.0	30.0	1	\$120.40
620-50-SP	G-Flex Wand, 4-5 MM	50	5.0	60.0	1	\$120.40
635-50-SP	G-Flex Wand, 6-8 MM	50	8.0	58.0	1	\$120.40
655-50-SP	G-Flex Wand, 10-3 MM	50	15.0	60.0	1	\$120.40
610-00	3 Pack of Brush Head Refills for 610		4.0	30.0	3	\$46.32
620-00	3 Pack of Brush Head Refills for 620		5.0	60.0	3	\$46.32
635-00	3 Pack of Brush Head Refills for 635		8.0	58.0	3	\$46.32
655-00	3 Pack of Brush Head Refills for 655		15.0	58.0	3	\$46.32
610-SU	Disposable Brushes for G-Flex 610 3-4 mm dia.		4.5	31.5	30	\$135.00
620-SU	Disposable Brushes for G-Flex 620 4-5 mm dia.		5.5	61.5	30	\$135.00
630-SU	Disposable Brushes for G-Flex 630 5-6 mm dia.		6.5	62.0	30	\$135.00
635-SU	Disposable Brushes for G-Flex 635 6-8 mm dia.		8.7	62.0	30	\$135.00
640-SU	Disposable Brushes for G-Flex 640 8-10 mm dia.		10.8	62.5	30	\$135.00
655-SU	Disposable Brushes for G-Flex 655 10-13 mm dia.		14.2	62.5	30	\$135.00
680-SU	Disposable Brushes for G-Flex 680 13-20 mm dia.		21.0	62.5	30	\$135.00

Brush Cleaning Tools



Code No	Description	Price
BR001	Brush Storage Rack	\$62.20
BRS03	Brush Soaking Tray	\$82.90
BSC-01	Brush Sizing Chart	\$20.75
BSK05	Washing Basket for Brushes	\$497.45
110C	LTA Brush Storage Rack	\$90.56

Pre-Cleaning Instrument Items

Code No	Description	QTY	Price
CC1212	Lint-Free Wipes 12" x 12"	150	\$51.85
CC1212B	Lint-Free Wipes Blue 12" x 12"	150	\$51.85
CC555	Lint-Free Wipes 9" x 9"	200	\$43.55
TX59	Ultra Microdenier Dry Wipes	100	\$146.63
ESD904101	Durasponge, Instrument Sponge, Tubular-Dry	100	\$62.20
ESD905201	Durasponge, Instrument Sponge, Flat-Dry	200	\$62.20

Pre-rinse Shower Unit

Code No	Description	Price
300718	Deck Mounted Spray Unit	\$1,095.00
300719	Splash Mounted Spray Unit	\$1,105.00
301189	Faucet Add-on with 12" Spout	\$293.00
301190	Wall Bracket	\$74.00
313116	Pre-Rinse Hose 36" Length	\$210.00
313323	Pre-Rinse Spray Valve Assembly	\$180.00

Flexible Endoscope Brushes



Code No	Description	Dia. (mm)	Length (cm)	Brush length (mm)	QTY	Price
00711610	Control Head/Valve Cleaning Brush	10	9	47	1	\$6.25
CC-100-100	Endoscope Brush (1.0 - 1.5 mm)	2.0	100	12.7	12	\$44.40
CC-601	Standard Brush (5.0 - 8.0 mm)	5.5	230	12.7	12	\$31.20
CC-603	Jumbo Brush (7.4 - 10.0 mm)	7.4	230	12.7	12	\$31.20
CC-110	Clear Channel Brush (1.1 - 1.6 mm)	1.2	200	12.7	12	\$31.20
CC-230-400	Tapered Bristle Brush (1.7 - 2.5 mm)	1.7	230	12.7	12	\$31.20
CC-230-600	Bristle Brush (2.6 - 4.9 mm)	6.0	230	42.5	12	\$31.20
CC-025-600	Endoscope Brush (2.0 - 3.2 mm)	6.0	25	12.7	12	\$25.00
CC-601-3770	Standard Brush w/Valve Brush Kit	5.5	230	12.7	12	\$54.00
CC-603-3770	Jumbo Brush w/Valve Brush Kit	7.4	230	12.7	12	\$54.00
CC-110-3770	Clear Channel Brush w/Valve Brush Kit	1.2	200	12.7	12	\$54.00
CC-172-3770	Tapered Bristle Brush w/Valve Brush Kit	1.7	230	12.7	12	\$54.00
CC-250-3770	Bristle Brush w/Valve Brush Kit	6.0	230	44.5	12	\$54.00
CC-374-3770	Tapered Bristle Brush w/Valve Brush Kit	3.7	230	12.7	12	\$54.00
EMB-001	Elevator Mechanism Brush	1.5	5	10	10	\$14.75

Spray Guns

Code No	Description	Price
6000	Spray Gun only	\$212.45
6000-6025	Spray Gun with plastic hose & 3/4" connector. Includes 1.5 meter hose (58 inches), 4230 spray tip and wall hook	\$316.10
6020	Spray Gun w/ 1.5 meter hose, 3/4" connector & complete tip set & rack	\$533.70
6000-6045	Spray Gun with plastic hose & 3/4" connector. Includes: 3 meter hose (117 inches), 4230 spray tip and wall hook	\$352.35
5070	Table-top Rosette	\$74.60
80-00-44	Replacement Kit - Flow Control	\$48.20
5120	Plumbing 3/4" connector	\$26.45
80-10-15	Plumbing 1/2" connector	\$26.45
4230	Universal Tip	\$22.30
4240	For drainage tube	\$22.30
4250	Spray jet for rinsing out glassware, etc.	\$22.30
5040	Rack Only for Tips	\$61.15
5220	Tip attachments - complete set of all 8 sizes	\$295.35
3020	Wall hook for spray gun	\$2.60
80-10-12	"O" Rings, 10 per package	\$3.15
4270	For syringes and cannulae with record cone	\$22.30
5010	For measuring and blood pipettes	\$22.30
4260	For syringes and cannulae with Luer cone	\$22.30
80-10-43	For bottles and Erlenmeyer flasks	\$39.90
80-10-44	Water jet pump for suction	\$67.40
64-20810-00	Stainless Steel Spray Gun Includes Kit	\$1,675.00

Ribbed/Vented
Tip
Defenders

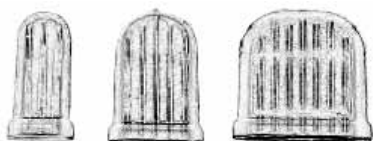

Economical Single-Use
Tip Protectors

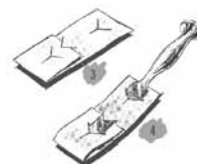

Code No	Dia. (mm)	Height (mm)	Width (mm)	Case	Price
10001	1.6	19.0		100	\$17.10
10002	1.9	19.0		100	\$17.10
10003	2.7	19.0		100	\$17.10
10004	3.2	25.0		100	\$17.10
10005	4.7	25.0		100	\$17.10
10006	10.5	19.0		100	\$17.10
10007	1.6	9.5	25.0	100	\$17.10
10008	1.6	16.0	25.0	100	\$17.10
10009	3.2	25.0	25.0	100	\$17.10
10010	6.3	19.0		100	\$17.10

Code No	Case Qty	Slot Dia. (mm)	Price
PPT001	2000/box, paper	15	\$160.65
PPT002	1000/box, paper	15	\$85.50
PPT003	2000/box, paper	30	\$160.65
PPT004	1000/box, paper	30	\$85.50
PPT005	2000/box, paper	5	\$160.65
PPT006	1000/box, paper	5	\$85.50
PPT007C	200/box, plastic	15	\$25.95
PPT008C	200/box, plastic	30	\$25.95

Vented Instrument Guards

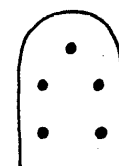

Opaque Code No	Color	Width (mm)	Height (mm)	Dia. (mm)	Case	Price	Clear Code No	Color	Price
09-1-011	White	1.50	19.10		100	\$30.00	09-2-011	Clear	\$30.00
09-1-012	Blue	2.00	19.10		100	\$30.00	09-2-012	Clear	\$30.00
09-1-013	Green	2.80	19.10		100	\$30.00	09-2-013	Clear	\$30.00
09-1-014	Red	3.30	25.40		100	\$30.00	09-2-014	Clear	\$30.00
09-1-015	Yellow	4.80	25.40		100	\$30.00	09-2-015	Clear	\$30.00
09-1-016	Maroon	10.20	19.10		100	\$30.00	09-2-016	Clear	\$30.00
09-1-017	Orange	1.50	9.70	25.40	100	\$30.00	09-2-017	Clear	\$30.00
09-1-018	Brown	2.00	15.90	25.40	100	\$30.00	09-2-018	Clear	\$30.00
09-1-019	Black	3.18	25.40	25.40	100	\$30.00	09-2-019	Clear	\$30.00
09-1-020	Asst. Colors & Sizes				100	\$30.00	09-2-020	Asst. Sizes - Clear	\$30.00

Prices are subject to change without prior notice

Duo-Vented Instrument Guards

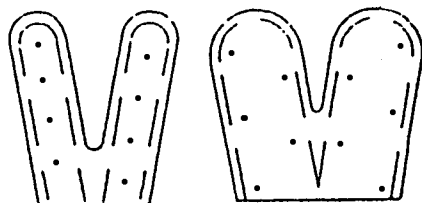

Code No	Color	Height (mm)	Width (mm)	Dia. (mm)	Case	Price
09-3-031	White Tint	1.50	19.10		50	\$32.50
09-3-032	Blue Tint	2.00	19.10		50	\$32.50
09-3-033	Green Tint	2.80	19.10		50	\$32.50
09-3-034	Red Tint	3.30	25.40		50	\$32.50
09-3-035	Yellow Tint	4.80	25.40		50	\$32.50
09-3-037	Orange Tint	1.50	9.70	1.00	50	\$32.50
09-3-040	Assorted sizes/colors				50	\$37.50

Mesh Style Instrument Protectors

Code No	Description	Length	Dia.	QTY	Price
CSW-03-2.0	Mesh Closed Style Tip Protector	70	6	100	\$32.05
CSW-04-4.0	Mesh Open End Sleeve Tip Protectors	102	13	100	\$22.00

Cylindrical Style Instrument Guards

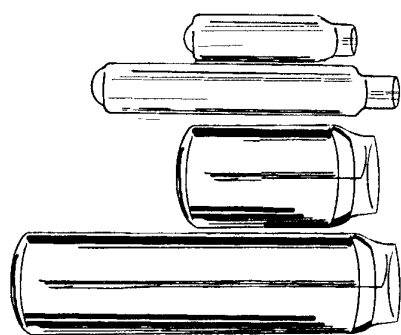

Code No	Description	Length (mm)	Dia. (mm)	Qty	Price
09-7-011	For Veress Needles	20.30	3.00	50	\$20.00
09-7-012	For all 5mm Instruments, trocars, Probes, etc.	30.30	5.00	25	\$17.50
09-7-013	For all 5mm Instruments, trocars, Probes, etc.	43.20	5.00	20	\$17.00
09-7-014	For all 10mm Instruments, trocars, Probes, etc.	20.30	10.00	25	\$17.50
09-7-015	For all 5mm Instruments, trocars, Probes, etc.	57.15	5.00	20	\$17.50

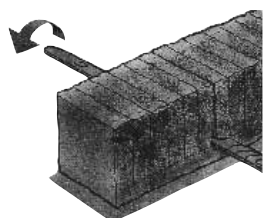

Foam Tray Anchors

Code No	Description	Price
ANC001	Pack of 16 strips	\$92.75
ANC002	Pack of 64 strips	\$258.05

Steri-Cel™ Instrument Foam Protection for Steam and EtO

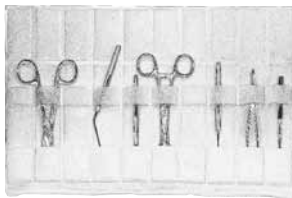

Code No	Description	Width	Length	Case	Price
SC4600	Roll	12.00	108.00	3	\$50.45
SC4800	Precut Sheets	12.00	10.00	50	\$37.35
SC4850	Precut Sheets	12.00	16.00	25	\$30.05
SC4880	Precut Sheets	12.00	20.00	25	\$49.75
SC5200	Pocket w/ Belts	11.00	15.00	10	\$50.30
SC5500	Multi-Pouch	13.00	17.00	10	\$80.35
SC6200	Rigid Scope Pouch	2.00	20.00	50	\$174.10
SC6210	Large Single Pouch	4.00	7.00	50	\$124.35
SC6250	Small Single Pouch	2.10	7.50	50	\$38.90
SC6270	Camera/Fiber-Optic Cable	9.50	10.00	10	\$84.50
SC6314	Small Flared Scope Pouch	3.63	1.75	25	\$118.75

Plasma-Cel™ Instrument Foam Protection for Plasma Sterilizers

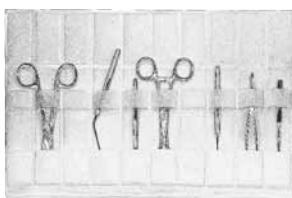

Code No	Description	Width	Length	Case	Price
PC4600	Roll	12.00	72.00	3	\$86.25
PC4800	Precut Sheets	12.00	10.00	50	\$155.00
PC4850	Precut Sheets	12.00	16.00	25	\$120.00
PC4880	Precut Sheets	12.00	20.00	25	\$177.50
PC5200	Pocket w/ Belts	11.00	15.50	10	\$111.00
PC5500	Multi-Pouch	13.00	17.00	10	\$127.50
PC6200	Rigid Scope Pouch	2.00	20.00	50	\$172.50
PC6210	Large Single Pouch	4.00	7.00	50	\$180.00
PC6250	Small Single Pouch	2.10	7.50	50	\$62.50



Instrument Repair Tags

Code No	Description	Qty	Price
994-G	Green - Good	100	\$18.15
994-R	Red - Repair	100	\$18.15
994-S	Yellow - Sharpen	100	\$18.15
5030 WT CLN	White Pulltight	100	\$25.95

Prices are subject to change without prior notice

Latex Scissor Test

Code No	Length	Width	Gauge	Qty	Price
LT-130	5.00	5.00	10	10	\$30.00
RT608	5.50	8.00	1	1	\$18.30
YT606	5.50	6.00	1	1	\$17.10

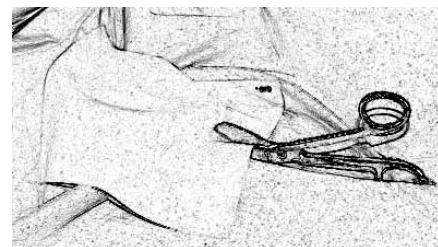

HotSpot Safe-to-Touch Indicators

Code No	Qty	Price
HS-101	50	\$98.45

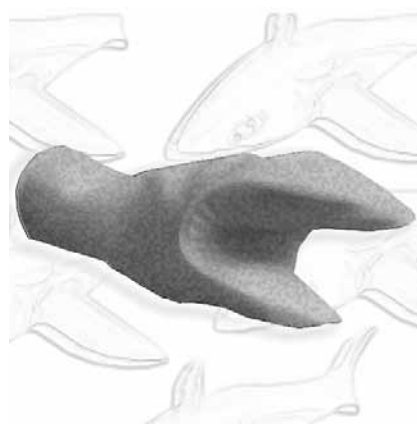

Insulated Gloves

Code No	Description	Length	Price
75574	Insulated Gauntlet (pair)	17.00	\$12.50
75524	Insulated Gauntlet (pair)	24.00	\$22.00
73224	Insulated Gauntlet (pair)	13.00	\$9.50
JB-2636	Seamless Autoclave Gloves (pair)	12.50	\$22.00
SLG-002	Shark Tooth Heat Mitt (each)	17.00	\$62.20
SLG-001	Shark Tooth Heat Mitt (each)	14.00	\$31.10
JB-422-5	Terry Cloth Autoclave Gloves (pair)	5.00	\$24.00
JB-422-11	Terry Cloth Autoclave Gloves (pair)	11.00	\$21.00
09484	Silicone Heat Glove - 16.9 In. L	16.90	\$23.00
09368	Silicone Heat Glove - 13.7 In. L	13.70	\$17.00

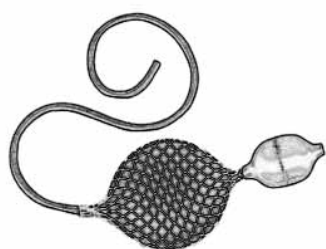

Disposable Bulb & Bladder

Code No	Description	Qty	Price
D30200-210	CLEAN (non-sterile) Disposable Bulb & Bladder Assembly	PKG-4	\$103.65
D30200-210S	STERILE Disposable Bulb & Bladder Assembly	CS-5	\$155.45

The Endo Parts Bag & Valvesafe

Code No	Description	Qty	Price
VB604 GN	Valve Bag-Green	100	\$25.00

Pro-Ties™ Bundling System

Code No	Color	Qty	Price
310-054	Yellow	6	\$25.95
310-053	Blue	6	\$25.95
310-052	Green	6	\$25.95
310-051	Red	6	\$25.95



Silicon Cable & Ties (Also available in a variety of colors)

Code No	Color	Qty	Price
09231	Clear Cable Ties, 4.3 In. - Cynched	25	\$33.00
09239	Clear Cable Ties, 8.3 In. - Cynched	25	\$39.00
09246	Clear Cable Ties, 2.4 In. - Cynched Wide	25	\$19.00
09373	Clear Cable Ties, 4.3 In. - Cynched Wide	25	\$34.00
09282	Clear Cable Ties, 7.5 In. - Cynched Wide	25	\$45.00
09039	Clear Cable Ties, 11.8 In. - Flat	25	\$11.00
09139	Clear Cable Ties, 19.6 In. - Flat	25	\$18.00

LBK Weighing Scale

Code No	Description	Price
LBK 65A	LBK Weighing Scale	\$265.00

Clamps & Spreaders

Code No	Description	Price
20407	Stainless Steel Instrument Spreader	\$30.60
20412	Stainless Steel Band Clamp W/Anti-Slide Covering-Green	\$30.60
20406	Stainless Steel Band Clamp W/Anti-Slide Covering-Red	\$30.60
20408	Stainless Steel Band Clamp W/Anti-Slide Covering-Blue	\$30.60
20411	Stainless Steel Band Clamp W/Anti-Slide Covering-Yellow	\$30.60

EasyStringer™



Code No	Color	Price
ES-100	6" Wide EasyStringer Base	\$72.55
ES-109	9" Wide EasyStringer Base	\$98.45
ES-112	12" Wide EasyStringer Base	\$114.00

Prices are subject to change without prior notice

Instrument Stringers

Code No	Description	Width	Rod Diameter	Length	Price
AJS 13	13" long x 2.5" - 5.5" wide				\$90.00
AJS 8	8" long x 2.5" - 5.5" wide				\$90.00
AJS 17	17" long x 2.5" - 5.5" wide				\$90.00
10-1770	Bunt Instrument Holder	1.50		5.25	\$19.35
IWC-001	Stainless Steel Wash Cradle	2.00	3.75	11.50	\$88.10
ST2.64C	Crescent Style	2.50	0.25	6.00	\$44.05
ST2.84C	Crescent Style	2.50	0.25	8.00	\$44.05
ST2.104C	Crescent Style	2.50	0.25	10.00	\$46.65
ST2.124C	Crescent Style	2.50	0.25	12.00	\$47.70
ST2.144C	Crescent Style	2.50	0.25	14.00	\$50.80
ST2.164C	Crescent Style	2.50	0.25	16.00	\$50.80
ST2.184C	Crescent Style	2.50	0.25	18.00	\$75.65
ST3-64C	Crescent Style	3.50	0.25	6.00	\$47.70
ST3-84C	Crescent Style	3.50	0.25	8.00	\$47.70
ST3-104C	Crescent Style	3.50	0.25	10.00	\$47.70
ST3-124C	Crescent Style	3.50	0.25	12.00	\$49.75
ST3-144C	Crescent Style	3.50	0.25	14.00	\$50.80
ST3-164C	Crescent Style	3.50	0.25	16.00	\$57.00
ST3-184C	Crescent Style	3.50	0.25	18.00	\$61.15
ST55-8	Pin Locking Stringer	5.50		8.00	\$55.00
ST-6	Pin Locking Stringer	2.75		6.00	\$45.00
HE8-0006	EZ Lok Double-Hinge Bar	2.50	0.19	6.00	\$71.50
HE8-0008	EZ Lok Double-Hinge Bar	2.50	0.19	8.00	\$74.65
HE8-0010	EZ Lok Double-Hinge Bar	2.50	0.19	10.00	\$80.85
HE8-0012	EZ Lok Double-Hinge Bar	2.50	0.19	12.00	\$85.00
HE8-0014	EZ Lok Double-Hinge Bar	2.50	0.19	14.00	\$87.05
HE8-0016	EZ Lok Double-Hinge Bar	2.50	0.19	16.00	\$95.35
HE8-0018	EZ Lok Double-Hinge Bar	2.50	0.19	18.00	\$99.50
HE2-0006	Hairpin Style, U-Shaped	2.50	0.19	6.00	\$36.30
HE2-0008	Hairpin Style, U-Shaped	2.50	0.19	8.00	\$40.45
USPRS-6	Spring Instrument Stringer	2.50	0.25	6.00	\$28.00
USPRS-8	Spring Instrument Stringer	2.50	0.25	8.00	\$29.00
USPRS-10	Spring Instrument Stringer	2.50	0.25	10.00	\$30.50
USPRS-12	Spring Instrument Stringer	2.50	0.25	10.00	\$32.25
USPRS-14	Spring Instrument Stringer	2.50	0.25	14.00	\$34.00
USPRS-16	Spring Instrument Stringer	2.50	0.25	16.00	\$36.25

Instrument Stringers

Code No	Description	Width	Rod Diameter	Length	Price
HE2-0010	Hairpin Style, U-Shaped	2.50	0.19	10.00	\$44.05
HE2-0012	Hairpin Style, U-Shaped	2.50	0.19	12.00	\$48.20
HE2-0014	Hairpin Style, U-Shaped	2.50	0.19	14.00	\$51.85
HE2-0016	Hairpin Style, U-Shaped	2.50	0.19	16.00	\$57.00
HE2-0018	Hairpin Style, U-Shaped	2.50	0.19	18.00	\$62.20
ST-064U	Hairpin Style, U-Shaped	2.50	0.25	6.00	\$31.10
ST-084U	Hairpin Style, U-Shaped	2.50	0.25	8.00	\$31.10
ST-104U	Hairpin Style, U-Shaped	2.50	0.25	10.00	\$31.10
ST-124U	Hairpin Style, U-Shaped	2.50	0.25	12.00	\$34.20
ST-144U	Hairpin Style, U-Shaped	2.50	0.25	14.00	\$36.30
ST-164U	Hairpin Style, U-Shaped	2.50	0.25	16.00	\$38.35
ST-184U	Hairpin Style, U-Shaped	2.50	0.25	18.00	\$42.50
ST3-06U	Hairpin Style, U-Shaped	3.50	0.19	6.00	\$26.95
ST3-08U	Hairpin Style, U-Shaped	3.50	0.19	8.00	\$26.95
ST3-10U	Hairpin Style, U-Shaped	3.50	0.19	10.00	\$26.95
ST3-12U	Hairpin Style, U-Shaped	3.50	0.19	12.00	\$29.05
ST3-14U	Hairpin Style, U-Shaped	3.50	0.19	14.00	\$31.10
ST3-16U	Hairpin Style, U-Shaped	3.50	0.19	16.00	\$33.20
ST3-18U	Hairpin Style, U-Shaped	3.50	0.19	18.00	\$37.35
ST3-064U	Hairpin Style, U-Shaped	3.50	0.25	6.00	\$31.10
ST3-084U	Hairpin Style, U-Shaped	3.50	0.25	8.00	\$31.10
ST3-104U	Hairpin Style, U-Shaped	3.50	0.25	10.00	\$31.10
ST3-124U	Hairpin Style, U-Shaped	3.50	0.25	12.00	\$34.20
ST3-144U	Hairpin Style, U-Shaped	3.50	0.25	14.00	\$36.30
ST3-164U	Hairpin Style, U-Shaped	3.50	0.25	16.00	\$38.35
ST3-184U	Hairpin Style, U-Shaped	3.50	0.25	18.00	\$42.50
ST5-064U	Hairpin Style, U-Shaped	5.00	0.25	6.00	\$33.20
ST5-084U	Hairpin Style, U-Shaped	5.00	0.25	8.00	\$33.20
ST5-104U	Hairpin Style, U-Shaped	5.00	0.25	10.00	\$33.20
ST5-124U	Hairpin Style, U-Shaped	5.00	0.25	12.00	\$37.35
ST5-144U	Hairpin Style, U-Shaped	5.00	0.25	14.00	\$39.40
ST5-164U	Hairpin Style, U-Shaped	5.00	0.25	16.00	\$41.45
ST5-184U	Hairpin Style, U-Shaped	5.00	0.25	18.00	\$46.65
HP6-12U	Hairpin Style, U-Shaped	6.00	0.19	12.00	\$41.45
10-1780	Saunders Instrument Rack	4.00		5.75	\$92.80
HE1-0006-W	Weinstein Instrument Holder	2.50		6.00	\$74.10
HE1-0008-W	Weinstein Instrument Holder	2.50		8.00	\$80.85

Instrument Stringers

Code No	Description	Width	Length	Price
HE1-0010-W	Weinstein Instrument Holder	2.50	10.00	\$84.50
HE1-0012-W	Weinstein Instrument Holder	2.50	12.00	\$88.10
HE1-0014-W	Weinstein Instrument Holder	2.50	14.00	\$93.30
HE1-0016-W	Weinstein Instrument Holder	2.50	16.00	\$96.40
HE1-0018-W	Weinstein Instrument Holder	2.50	18.00	\$99.50
10-1805	Weinstein Instrument Holder	3.00	11.25	\$88.10
10-1775	Weisenbach Instrument Forceps		6.00	\$92.80
10-1776	Weisenbach Instrument Forceps		13.50	\$92.80

Ultrasonic Cleaning Pouch

Code No	Description	Length	Width	Price
8001	Ultrasonic Cleaning Pouch	5.00	8.00	\$55.00
8002	Ultrasonic Cleaning Pouch	8.00	12.00	\$70.00
8003	Ultrasonic Cleaning Pouch	8.00	18.00	\$82.90

Washer Baskets

Code No	Description	Length	Width	Height	Price
75.0005.3	Wire Basket	9.500	9.875	2.000	\$145.00
75.0004.6	Wire Basket	9.500	9.875	2.750	\$135.00
75.0005.9	Wire Basket	18.875	9.875	2.000	\$220.00
75.0004.8	Wire Basket	18.875	9.875	2.750	\$220.00
75.0004.9	Wire Basket	18.875	9.875	4.000	\$220.00
75.0091.2	Cover	9.500	9.875		\$191.75
75.0091.1	Cover	18.875	9.875		\$191.75
72.1400.5	Large Washer Basket	23.667	15.750	4.000	\$255.00
72.1400.6	Large Washer Basket	23.667	15.750	7.875	\$265.00
NIC000	Round Nic-Nac Basket		3.000	3.000	\$91.20
NIC001	Round Nic-Nac Basket		4.000	1.250	\$155.45
21000-H	Hinged Parts Basket	3.000	1.000	1.000	\$61.40
NIC002	Nic-Nac Basket	7.000	5.000	1.000	\$155.45
NIC003	Nic-Nac Basket	7.000	9.000	1.000	\$176.20
NIC MICRO 1	Round Nic-Nac Basket w/Handle (3/pkg)	1.750			\$17.25
NIC MICRO 2A	Round Nic-Nac Basket (3/pkg)	2.000			\$17.10
NIC MICRO 2	Round Nic-Nac Basket (3/pkg)	2.500			\$20.25
NIC MICRO 3	Round Nic-Nac Basket (3/pkg)	3.000			\$20.75

Stainless Steel Washing Sleeves

Code No	Description	Qty	Price
07433	SS Washing Sleeve - 2.16 In (55 mm)	1	\$35.00
07436	SS Washing Sleeve - 8.66 In (220 mm)	1	\$139.00
07439	SS Washing Sleeve - 15.16 (385 mm)	1	\$243.00
07441	SS Washing Sleeve - 19.48 (495 mm)	1	\$313.00

Paper Bags

Code No	Description	Width	Length	Height	Case	Price
PB1	Paper Bags	3.50	6.00	2.00	1000	\$54.35
PB2	Paper Bags	4.00	7.00	1.00	1000	\$55.30
PB3	Paper Bags	4.70	10.00	2.00	1000	\$74.65
PB4	Paper Bags	5.50	10.00	3.00	1000	\$108.85
PB5	Paper Bags	5.50	13.00	2.00	500	\$57.00
PB7	Paper Bags	7.00	15.00	3.75	500	\$102.40
PB8	Paper Bags	7.50	13.00	2.50	500	\$59.25
PB9	Paper Bags	9.75	15.00	4.00	250	\$45.30
PB10	Paper Bags	11.75	20.75	3.00	250	\$70.35
PBR-15	7 pouches, 1.5" wide	10.00	14.00		100	\$38.35
PBR-35	4 pouches, 3.0" wide	10.00	14.00		100	\$31.10
PBTO	Time Out Bag	5.00	13.00	2.00	500	\$60.60

Optical Products

Code No	Color	Price
26043	Pocket Magnifier	\$7.80
26106	OptiVisor	\$93.30
26501-DSG	Adjustable Arm Magnifier	\$285.00
26501-B22	Replacement Bulb for 26501-DSG	\$24.20
26505-SIV	WideView Magnifying Lamp	\$207.25
26505-B09	Replacement Bulb for 26505-SIV	\$12.45
26508-LED2	ProVue Touch LED Magnifying Lamp	\$409.35
MG10081-8	Pocket Microscope	\$20.00
MICR007	USB mighty scope slim microscope w/aluminum stand	\$300.00
FIS-001	Flexible Inspection Scope	\$4995.00
100657-K	Flexarm Kit	\$123.00
42400-4 RD	6" Round Red LED Magnifier	\$748.00
82400-4 BL	7" x 5.25" Retangular Blue LED Magnifier	\$935.00
DB-LM-20	4" DeskBrite LED Magnifier	\$45.00