

FLEXISTEM Small Channel Cleaners

Code No	Description	Length (ft.)	Dia. (mm)	Price
FLEX001	Soft Cleaner - Roll	40.0	3.0	\$10.50
FLEX002	Super Bristle - Roll	40.0	3.0	\$12.00
FLEX003	Double Clean Stem - 100 each	0.5	3.0	\$31.10
FLEX033	Polypropylene Flexistem - 50 each	1.0	3.0	\$20.75
FLEX004	Fleece Stem - 50 each	1.0	9.0	\$28.50
FLEX005	Fleece Stem - 50 each	1.0	12.0	\$31.10
FLEX006	Bristle Stem - 20 each	1.0	15.0	\$20.75
FLEX007	Bristle Stem - Roll	20.0	15.0	\$18.65
FLEX007A	Wavy Stem - 20Ft Roll (3 mm - 15mm dia.)			\$18.65
FLEX008	Dispenser and 1 pack of each			\$309.85
FLEX009	Complete Refill Pack			\$155.45

FLEXISTEM Ultra Channel Cleaners

Code No	Description	Length (in.)	Dia. (mm)	Price
FLEX021	Super Fine - Roll	6.0	3.0	\$16.60
FLEX022	Medium Fine - Roll	6.0	6.0	\$17.65
FLEX023	Super Brush - Roll	6.0	3.0	\$19.45
FLEX024	Medium Brush - Roll	6.0	6.0	\$20.75
FLEX025	Dispenser and 1 pack of each			\$206.25
FLEX026	Complete Refill Pack			\$72.55

ProSys™ Instrument Cleaning Brushes

Code No	Description	Overall Length (cm)	Diameter (mm)	Brush Part (mm)	Qty	Price
CCBRK-1	Complete Brush Kit with Storage Rack				1	\$102.60
RPCBRK-1	Complete Brush Kit w/o Storage Rack				1	\$72.50
4030	Standard Tube Brush	6.25	6.00	51.00	1	\$1.65
4031	Standard Tube Brush	6.25	10.00	51.00	1	\$1.90
52003-35	For Verres Needles	20.32	1.40	25.00	12	\$61.95
4032	Standard Tube Brush	21.59	13.00	76.00	1	\$2.10
4033	Standard Tube Brush	21.59	16.00	76.00	1	\$2.20
4034	Standard Tube Brush	21.59	19.00	76.00	1	\$2.00
TR350109	Special Tube Brush	30.00	2.00	20.00	3	\$9.70
TR350232	Special Tube Brush	30.00	3.00	20.00	3	\$9.70
TR350233	Special Tube Brush	30.00	4.00	20.00	3	\$9.70
TR350354	Special Tube Brush	30.00	5.00	20.00	3	\$9.70

Code No	Description	Overall Length (cm)	Diameter (mm)	Brush Part (mm)	Qty	Price
TR350429	Special Tube Brush	30.00	6.00	20.00	3	\$9.70
52003-25	For 8mm Trocar Sleeves	31.00	8.00	76.00	12	\$55.45
10-1660	Special Tube Brush	31.00	3.20	57.00	3	\$57.75
52003-21-S	For 3mm Trocar & 6mm Biopsy Tongs	30.00	3.00	57.00	12	\$55.45
52003-27	For 10mm Trocar Sleeves	31.00	10.00	76.00	12	\$55.45
4035	Standard Tube Brush	32.00	25.00	102.00	1	\$3.35
4041	Standard Tube Brush	33.00	11.00	89.00	3	\$10.55
4036	Standard Tube Brush	33.00	32.00	102.00	1	\$3.40
4037	Standard Tube Brush	33.00	38.00	102.00	1	\$3.90
4038	Standard Tube Brush	33.00	44.00	102.00	1	\$5.40
4039	Standard Tube Brush	33.00	51.00	102.00	1	\$5.65
10-1664	Special Tube Brush	38.00	9.50	64.00	3	\$75.75
10-1668	Special Tube Brush	38.00	19.00	89.00	3	\$60.00
24-1-035	Cleaning Brush, White Nylon, 15 FR	41.00	4.82	64.00	6	\$52.50
24-1-040	Cleaning Brush, White Nylon, 18 FR	41.00	6.00	64.00	6	\$52.50
24-1-055	Cleaning Brush, White Nylon, 45 FR	41.00	15.00	64.00	6	\$52.50
24-1-045	Cleaning Brush, White Nylon, 33 FR	41.00	11.00	64.00	6	\$52.50
24-1-050	Cleaning Brush, White Nylon, 36 FR	41.00	12.00	64.00	6	\$52.50
24-1-060	Cleaning Brush, White Nylon, 60 FR	41.00	20.00	64.00	6	\$52.50
24-1-007	Cleaning Brush, White Nylon, 3 FR	46.00	0.75	13.00	6	\$52.50
24-1-010	Cleaning Brush, White Nylon, 4.5 FR	46.00	1.50	13.00	6	\$52.50
24-1-015	Cleaning Brush, White Nylon, 5 FR	46.00	2.00	13.00	6	\$52.50
24-1-020	Cleaning Brush, White Nylon, 6.6 FR	46.00	2.25	13.00	6	\$52.50
24-1-025	Cleaning Brush, White Nylon, 8 FR	46.00	2.50	25.00	6	\$52.50
24-1-030	Cleaning Brush, White Nylon, 9 FR	46.00	3.30	25.00	6	\$52.50
52003-21	For 3mm Trocar & 6mm Biopsy Tongs	48.00	3.00	76.00	12	\$55.45
52003-23	For 6mm Trocar Sleeves	48.00	6.00	76.00	12	\$55.45
52003-33	For 3mm Biopsy Tongs	48.00	3.00	76.00	12	\$55.45
TR03020	Special Tube Brush	51.00	0.70	13.00	3	\$17.60
130-14	Special Tube Brush	53	6.40	102.00	3	\$14.85
130-38	Special Tube Brush	53	9.50	102.00	3	\$14.85
24-1-041	Cleaning Brush, White Nylon, 18 FR	61	6.00	64.00	6	\$52.50
24-1-046	Cleaning Brush, White Nylon, 33 FR	61	11.00	64.00	6	\$52.50
4042	Standard Tube Brush	61.00	13.00	76.00	3	\$13.55
TR360231	Special Tube Brush	61.00	2.50	76.00	3	\$11.20
TR150221	Special Tube Brush	61.00	5.00	76.00	3	\$8.25
TR150483	Special Tube Brush	61.00	7.00	76.00	3	\$8.25
TR160617	Special Tube Brush	61.00	10.00	76.00	3	\$8.25

Prices are subject to change without prior notice

Code No	Description	Overall Length (cm)	Diameter (mm)	Qty	Price
ITB-30-2	Cleaning Brush	30.00	2.00	30	\$57.75
ITB-30-4	Cleaning Brush	30.00	4.00	30	\$25.20
ITB-30-6	Cleaning Brush	30.00	6.00	30	\$31.50
ITB-30-9	Cleaning Brush	30.00	9.00	30	\$39.38
ITB-30-12	Cleaning Brush	30.00	12.00	30	\$49.22
ITB-30-15	Cleaning Brush	30.00	15.00	30	\$61.62
ITB-60-2	Cleaning Brush	60.00	2.00	30	\$64.05
ITB-60-4	Cleaning Brush	60.00	4.00	30	\$31.50
ITB-60-6	Cleaning Brush	60.00	6.00	30	\$44.10
ITB-60-9	Cleaning Brush	60.00	9.00	30	\$55.13
ITB-60-12	Cleaning Brush	60.00	12.00	30	\$68.91
ITB-60-15	Cleaning Brush	60.00	15.00	30	\$86.13

Instrument Inspection Tips

Code No	Description	Overall Length (cm)	Diameter (mm)	Qty	Price
ITS-30-110	Inspection Tips	30.00	1.10	30	\$81.30
ITS-30-270	Inspection Tips	30.00	2.70	30	\$53.70
ITS-30-420	Inspection Tips	30.00	4.20	30	\$60.00
ITS-60-110	Inspection Tips	60.00	1.10	30	\$88.50
ITS-60-270	Inspection Tips	60.00	2.70	30	\$76.80
ITS-60-420	Inspection Tips	60.00	4.20	30	\$82.80

ProSys™ Instrument Cleaning Brushes

Code No	Description	Overall Length (cm)	Diameter (mm)	Brush Part (mm)	Qty	Price
86-0340-1206	Shaver Brush	15.00	12.70	45.00		\$8.85
86-1234-0006	Shaver Brush	15.00	19.05	57.00		\$7.55
86-0516-1212	Shaver Brush	33.00	8.89	76.00	1	\$6.75
86-00004-0009	Shaver Brush	23.00	7.10	29.00	1	\$8.85
86-021201234	Shaver Brush	15.00	12.70	57.00	1	\$8.85
RB181603	Reamer Brush	46.00	16.00	76.00	1	\$17.10
RB300105	Reamer Brush	76.00	5.00	51.00	1	\$17.10
RB310306	Reamer Brush	79.00	6.00	76.00	1	\$20.70
RB310307	Reamer Brush	79.00	7.00	76.00	1	\$20.70
3770	Trumpet Valve Brush (12mm & 4mm)	15.60	12.00	7.00	1	\$2.35



Toothbrush Style Brushes

Code No	Description	Length	Width	Trim	QTY	Price
200599	Double Ended Brass Brush	18	13.00	13.00	1	\$4.95
200499	Double Brush/Stainless	18	13.00	13.00	1	\$5.20
200399-S	Double Ended Brush - PKG Sterile	18	13.00	13.00	20	\$124.35
200399	Double Brush/Nylon	18	13.00	13.00	1	\$4.40
C-1002	brass (pack of 3 brushes)	18	38.00	13.00	3	\$18.40
3182-P	stainless	20	38.00	13.00	1	\$1.30
3181-P	nylon	20	38.00	13.00	1	\$1.30
221 SN	nylon & stainless	120	38.00	13.00	1	\$5.10

Block Style Brushes



Code No	Description	Length	Width	Trim	Price
869903N	Nylon	2.50	3.00	1.25	\$7.50
3090	Stainless	10.00	1.00	1.25	\$9.15
4007	Nylon	10.00	1.00	1.25	\$8.55
GDS-1	Nylon, w/Surgical Nail Brush	4.00	1.60	0.50	\$1.80
GDS-2	Nylon	4.10	1.60	0.50	\$1.85



Bipolar Forceps Cleaner

Code No	Description	Price
DIA001	Bipolar Forceps Cleaner Set - Stainless	\$29.55

LTA Instrument Cleaning Brushes

Code No	Description	Overall Length (cm)	Diameter (mm)	Brush Part (mm)	Qty	Price
570	Precision Extn Micro Brush	16.00		32.00	1	\$47.38
540	Reamer w/ Ridgid Fibers	17.00		45.00	1	\$47.38
550	Cleaning Brush-Long Rigid Fibers				1	\$78.89
560	Precision Extn Brush w/ Rigid Fibers	17.00		43.00	1	\$47.38
560 CURVE	Acetabular Reamer Brush				1	\$47.38
510	External Brush w/ Rigid Bristles	22.00		76.00	1	\$77.18
510C	Extnl Brush w/ Short Rigid Bristles	22.00		76.00	1	\$77.18
520	External Brush w/ Med Bristles	22.00		76.00	1	\$77.18
410	Precision Extn Brush w/ Rigid Fibers				1	\$88.93
530	Extnl Brush w/ Soft white Fibers				1	\$78.89
565	Instrument Shaver Brush				1	\$85.50
545	Double End Acetabular Reamer				1	\$75.00
610-25-SP	G-Flex Wand & Brush, 3-4 MM	25.00	4.00	30.00	1	\$85.47
620-25-SP	G-Flex Wand & Brush, 4-5 MM	25.00	5.00	60.00	1	\$85.47
635-25-SP	G-Flex Wand & Brush, 6-8 MM	25.00	8.00	58.00	1	\$85.47
655-25-SP	G-Flex Wand & Brush, 10-13 MM	25.00	15.00	60.00	1	\$85.47
610-50-SP	G-Flex Wand & Brush, 3-4 MM	50.00	4.00	30.00	1	\$120.40
620-50-SP	G-Flex Wand & Brush, 4-5 MM	50.00	5.00	60.00	1	\$120.40
635-50-SP	G-Flex Wand & Brush, 6-8 MM	50.00	8.00	58.00	1	\$120.40
655-50-SP	G-Flex Wand & Brush, 10-13 MM	50.00	15.00	60.00	1	\$120.40
610-00	3 Pack of Brush Head Refills for 610		4.00	30.00	3	\$46.32
620-00	3 Pack of Brush Head Refills for 620		5.00	60.00	3	\$46.32
635-00	3 Pack of Brush Head Refills for 635		8.00	58.00	3	\$46.32
655-00	3 Pack of Brush Head Refills for 655		15.00	58.00	3	\$46.32
610-SU	Disposable Brush Head for G-Flex 610 3-4 mm dia.		4.50	31.50	30	\$135.00
620-SU	Disposable Brush Head for G-Flex 620 4-5 mm dia.		5.50	61.50	30	\$135.00
630-SU	Disposable Brush Head for G-Flex 630 5-6 mm dia.		6.50	62.00	30	\$135.00
635-SU	Disposable Brush Head for G-Flex 635 6-8 mm dia.		8.70	62.00	30	\$135.00
640-SU	Disposable Brush Head for G-Flex 640 8-10 mm dia.		10.80	62.50	30	\$135.00
655-SU	Disposable Brush Head for G-Flex 655 10-13 mm dia.		14.20	62.50	30	\$135.00

Code No	Description	Overall Length (cm)	Diameter (mm)	Brush Part (mm)	Qty	Price
740-30	Flexible Brushes 1-1.4mm	30.00			1	\$48.00
740-50	Flexible Brushes 1-1.4mm	50.00			1	\$56.87
750-30	Flexible Brushes 1.4-2.4mm	30.00			1	\$48.00
750-50	Flexible Brushes 1.4-2.4mm	50.00			1	\$56.87
760-30	Flexible Brushes 2.4-3.4mm	30.00			1	\$48.00
760-50	Flexible Brushes 2.4-3.4mm	50.00			1	\$56.87
770-30	Flexible Brushes 3.4-4.4mm	30.00			1	\$48.00
770-50	Flexible Brushes 3.4-4.4mm	50.00			1	\$56.87
780-30	Flexible Brushes 4-5mm	30.00			1	\$48.00
780-50	Flexible Brushes 4-5mm	50.00			1	\$56.87

Non-Linting Wipes and Sponges

Code No	Description	QTY	Price
NLW002	Lint-Free Wipes 12" x 12"	150	\$51.85
NLW003	Lint-Free Wipes Blue 12" x 12"	150	\$51.85
NLW001	Lint-Free Wipes 9"x 9"	200	\$43.55
TX59	Ultra Microdenier Dry Wipes	100	\$146.63
SSW-001	Sterile Wipes 9 x 9 Inches	10	\$50.00
ESD904101	Durasponge, Instrument Sponge, Tubular-Dry	100	\$62.20
ESD905201	Durasponge, Instrument Sponge, Flat-Dry	200	\$62.20

Pre-rinse Shower Unit

Code No	Description	Price
300718	Deck Mounted Spray Unit	\$1,196.00
300719	Splash Mounted Spray Unit	\$1,206.50
301189	Faucet Add-on with 12" Spout	\$317.00
301190	Wall Bracket	\$81.00
313116	Pre-Rinse Hose 36" Length	\$230.00
313323	Pre-Rinse Spray Valve Assembly	\$196.75

Prices are subject to change without prior notice

Brush Cleaning Tools



Code No	Description	Price
BR001	Brush Storage Rack	\$62.20
BRS03	Brush Soaking Tray	\$82.90
BSC-01	Brush Sizing Chart	\$20.75
BSK05	Washing Basket for Brushes	\$525.00
110C	LTA Brush Storage Rack	\$90.56



Flexible Endoscope Brushes

Code No	Description	Dia. (mm)	Length (cm)	Brush length (mm)	QTY	Price
00711610	Control Head/Valve Cleaning Brush	10	9	47	1	\$6.25
CC-100-100	Endoscope Brush (1.0 - 1.5 mm)	2.0	100	12.7	12	\$44.40
CC-603	Jumbo Brush (7.4 - 10.0 mm)	7.4	230	12.7	12	\$31.20
CC-200-200	Clear Channel Brush (1.1 - 1.6 mm)	1.2	200	12.7	12	\$31.20
CC-230-400	Tapered Bristle Brush (1.7 - 2.5 mm)	4.0	230	12.7	12	\$31.20
CC-230-600	Bristle Brush (2.6 - 4.9 mm)	6.0	230	42.5	12	\$31.20
CC-025-600	Endoscope Brush (2.0 - 3.2 mm)	6.0	25	12.7	12	\$25.00
CC-230-900-3770	Standard Brush w/Valve Brush Kit	5.5	230	12.7	12	\$54.00
CC-603-3770	Jumbo Brush w/Valve Brush Kit	7.4	230	12.7	12	\$54.00
CC-200-200-3770	Clear Channel Brush w/Valve Brush Kit	2.0	200	12.7	12	\$54.00
CC-230-400-3770	Tapered Bristle Brush w/Valve Brush Kit	4.0	230	12.7	12	\$54.00
CC-230-600-3770	Bristle Brush w/Valve Brush Kit	6.0	230	44.5	12	\$54.00
EMB-002	Elevator Mechanism Brush	3.0	5	10	10	\$14.75

Silicone Mesh Covers

Code No	Description	QTY	Price
08881	Silicone Mesh Cover-Flexible Frame 16.9 x 9.1 inch	1	\$100.00
08882	Silicone Mesh Cover-Steel Frame 17.5 x 9.1 inch	1	\$200.00
08845	Silicone Mesh Cover-Steel Frame 9.3 x 8.3 inch	1	\$125.00
08846	Silicone Mesh Cover-Flexible Frame 9.3 x 8.3 inch	1	\$95.00

Spray Guns

Code No	Description	Price
6000	Spray Gun only	\$212.45
6000-6025	Spray Gun with plastic hose & 3/4" connector. Includes 1.5 meter hose (58 inches), 4230 spray tip and wall hook	\$316.10
6020	Spray Gun w/ 1.5 meter hose, 3/4" connector & complete tip set & rack	\$533.70
6000-6045	Spray Gun with plastic hose & 3/4" connector. Includes: 3 meter hose (117 inches), 4230 spray tip and wall hook	\$352.35
5070	Table-top Rosette	\$74.60
80-00-44	Replacement Kit - Flow Control	\$48.20
14RVT	Replacement Hose (Per Foot)	\$3.00
5120	Plumbing 3/4" connector	\$26.45
5110	Plumbing 1/2" connector	\$26.45
4230	Universal Tip	\$22.30
4240	For drainage tube	\$22.30
4250	Spray jet for rinsing out glassware, etc.	\$22.30
5040	Rack Only for Tips	\$61.15
5220	Tip attachments - complete set of all 8 sizes	\$295.35
1HGL4	Hook for spray gun	\$8.00
80-10-12	"O" Rings, 10 per package	\$3.15
4270	For syringes and cannulae with record cone	\$22.30
5010	For measuring and blood pipettes	\$22.30
4260	For syringes and cannulae with Luer cone	\$22.30
80-10-43	For bottles and Erlenmeyer flasks	\$39.90
80-10-44	Water jet pump for suction	\$67.40

Ribbed/Vented
Tip
Defenders

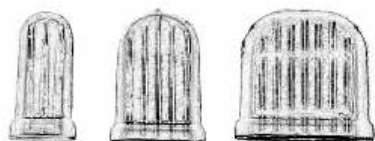

Economical Single-Use
Tip Protectors

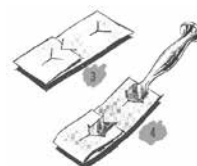

Code No	Dia. (mm)	Height (mm)	Width (mm)	Case	Price
10001	1.6	19.0		100	\$18.00
10002	1.9	19.0		100	\$18.00
10003	2.7	19.0		100	\$18.00
10004	3.2	25.0		100	\$18.00
10005	4.7	25.0		100	\$18.00
10006	10.5	19.0		100	\$18.00
10007	1.6	9.5	25.0	100	\$18.00
10008	1.6	16.0	25.0	100	\$18.00
10009	3.2	25.0	25.0	100	\$18.00
10010	6.3	19.0		100	\$18.00

Code No	Case Qty	Slot Dia. (mm)	Price
PP-001	2000/box, paper	15	\$160.65
PP-002	1000/box, paper	15	\$85.50
PP-003	2000/box, paper	30	\$160.65
PP-004	1000/box, paper	30	\$85.50
PP-005	2000/box, paper	5	\$160.65
PP-006	1000/box, paper	5	\$85.50
PO-007C	200/box, plastic	15	\$25.95
PO-008C	200/box, plastic	30	\$25.95
15.100.055	100/box	32	\$34.00

Vented Instrument Guards



Opaque Code No	Color	Width (mm)	Height (mm)	Dia. (mm)	Case	Price	Clear Code No	Color	Price
09-1-011	White	1.50	19.10		100	\$30.00	09-2-011	Clear	\$30.00
09-1-012	Blue	2.00	19.10		100	\$30.00	09-2-012	Clear	\$30.00
09-1-013	Green	2.80	19.10		100	\$30.00	09-2-013	Clear	\$30.00
09-1-014	Red	3.30	25.40		100	\$30.00	09-2-014	Clear	\$30.00
09-1-015	Yellow	4.80	25.40		100	\$30.00	09-2-015	Clear	\$30.00
09-1-016	Maroon	10.20	19.10		100	\$30.00	09-2-016	Clear	\$30.00
09-1-017	Orange	1.50	9.70	25.40	100	\$30.00	09-2-017	Clear	\$30.00
09-1-018	Brown	2.00	15.90	25.40	100	\$30.00	09-2-018	Clear	\$30.00
09-1-019	Black	3.18	25.40	25.40	100	\$30.00	09-2-019	Clear	\$30.00
09-1-020	Asst. Colors & Sizes				100	\$30.00	09-2-020	Asst. Sizes - Clear	\$30.00

Duo-Vented Instrument Guards

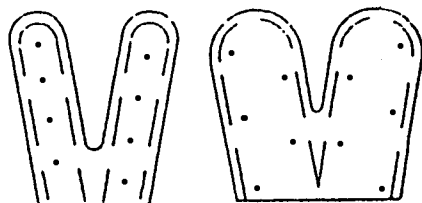

Code No	Color	Height (mm)	Width (mm)	Dia. (mm)	Case	Price
09-3-031	White Tint	1.50	19.10		50	\$32.50
09-3-032	Blue Tint	2.00	19.10		50	\$32.50
09-3-033	Green Tint	2.80	19.10		50	\$32.50
09-3-034	Red Tint	3.30	25.40		50	\$32.50
09-3-035	Yellow Tint	4.80	25.40		50	\$32.50
09-3-037	Orange Tint	1.50	9.70	1.00	50	\$32.50
09-3-040	Assorted sizes/colors				50	\$37.50

Mesh Style Instrument Protectors

Code No	Description	Length	Dia.	QTY	Price
CSW-03-2.0	Mesh Closed Style Tip Protector	70	6	100	\$32.05
CSW-04-4.0	Mesh Open End Sleeve Tip Protectors	102	13	100	\$22.00

Cylindrical Style Instrument Guards

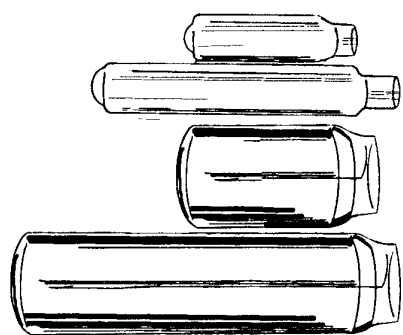

Code No	Description	Length (mm)	Dia. (mm)	Qty	Price
09-7-011	For Veress Needles	20.30	3.00	50	\$20.00
09-7-012	For all 5mm Instruments, trocars, Probes, etc.	30.30	5.00	25	\$17.50
09-7-013	For all 5mm Instruments, trocars, Probes, etc.	43.20	5.00	20	\$17.00
09-7-014	For all 10mm Instruments, trocars, Probes, etc.	20.30	10.00	25	\$17.50
09-7-015	For all 5mm Instruments, trocars, Probes, etc.	57.15	5.00	20	\$17.50

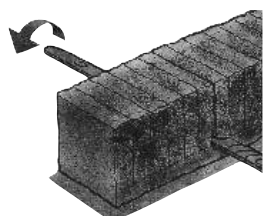

Foam Tray Anchors

Code No	Description	Price
FTA-201	Pack of 16 strips	\$92.75
FTA-204	Pack of 64 strips	\$258.05

Reticulated Instrument Foam Protection for Steam and EtO

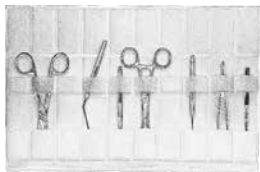

Code No	Description	Width	Length	Case	Price
FP-4800	Precut Sheets	12.00	10.00	50	\$37.35
FP-4880	Precut Sheets	12.00	20.00	25	\$49.75
FP-5200	Pocket w/ Belts	11.00	15.00	10	\$50.30
FP-6200	Rigid Scope Pouch	2.00	20.00	50	\$174.10
FP-6250	Small Single Pouch	2.10	7.50	50	\$38.90
SC6270	Camera/Fiber-Optic Cable	9.50	10.00	10	\$84.50
SC6314	Clean Sm Flared Scope Pouch	3.63	1.75	25	\$118.75
FP-1001	Foam Pouch			50	\$81.00
FP-1002	Foam Tip Protector			50	\$27.00
FP-1003	Foam Pinhole Holder			50	\$126.00
FP-1004	Foam Corner Protectors (Set of 4)			4	\$2.60
FP-1005	12 Instrument Foam Protector			50	\$216.00

Plasma-Cel™ Instrument Foam Protection for Plasma Sterilizers

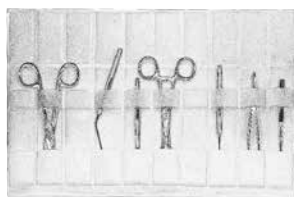

Code No	Description	Width	Length	Case	Price
PC4600	Roll	12.00	72.00	3	\$86.25
PC4800	Precut Sheets	12.00	10.00	50	\$155.00
PC4850	Precut Sheets	12.00	16.00	25	\$120.00
PC4880	Precut Sheets	12.00	20.00	25	\$177.50
PC5200	Pocket w/ Belts	11.00	15.50	10	\$111.00
PC5500	Multi-Pouch	13.00	17.00	10	\$127.50
PC6200	Rigid Scope Pouch	2.00	20.00	50	\$172.50
PC6210	Large Single Pouch	4.00	7.00	50	\$180.00
PC6250	Small Single Pouch	2.10	7.50	50	\$62.50

Instrument Repair Tags



Code No	Description	Qty	Price
994-G	Green - Good	100	\$18.15
994-R	Red - Repair	100	\$18.15
994-S	Yellow - Sharpen	100	\$18.15

Latex Scissor Test

Code No	Length	Width	Gauge	Qty	Price
LT-130	5.00	5.00	16	1	\$30.00
RT608	5.50	8.00	8	1	\$18.30
YT606	5.50	6.00	6	1	\$17.10

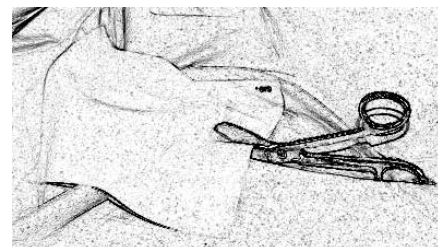

HotSpot Safe-to-Touch Indicators

Code No	Qty	Price
HS-101	50	\$98.45

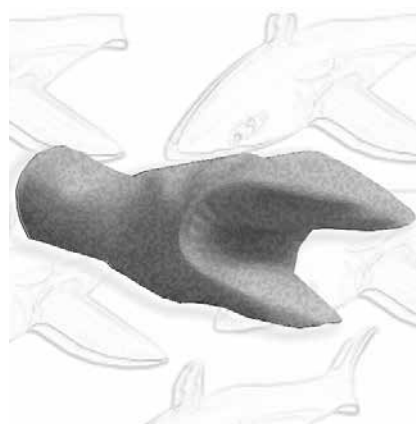

Insulated Gloves

Code No	Description	Length	Price
75574	Insulated Gauntlet (pair)	17.00	\$12.50
75524	Insulated Gauntlet (pair)	24.00	\$22.00
73224	Insulated Gauntlet (pair)	13.00	\$15.00
JB-2636	Seamless Autoclave Gloves (pair)	12.50	\$22.00
SLG-002	Shark Tooth Heat Mitt (each)	17.00	\$62.20
SLG-001	Shark Tooth Heat Mitt (each)	14.00	\$31.10
JB-422-5	Terry Cloth Autoclave Gloves (pair)	5.00	\$24.00
JB-422-11	Terry Cloth Autoclave Gloves (pair)	11.00	\$21.00
09484	Silicone Heat Glove - 16.9 In. L	16.90	\$23.00
09368	Silicone Heat Glove - 13.7 In. L	13.70	\$17.00

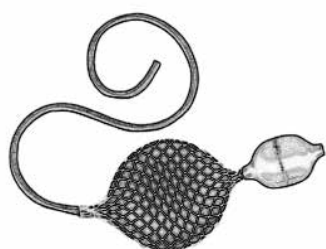

Disposable Bulb & Bladder

Code No	Description	Qty	Price
D30200-210	CLEAN (non-sterile) Disposable Bulb & Bladder Assembly	PKG-4	\$103.65
D30200-210S	STERILE Disposable Bulb & Bladder Assembly	CS-5	\$165.00

Valve Bags

Code No	Description	Qty	Price
VB604 GN	Valve Bag-Green	100	\$25.00
SVB604 WT CLN	Secure Valve Bag - White - with Clean Lok	100	\$65.00
SVB604 WT	Secure Valve Bag - White - with Num Lok	100	\$65.00

Pro-Ties™ Bundling System

Code No	Color	Qty	Price
310-054	Yellow	6	\$25.95
310-053	Blue	6	\$25.95
310-052	Green	6	\$25.95
310-051	Red	6	\$25.95



Silicon Cable & Ties (Also available in a variety of colors)

Code No	Color	Qty	Price
09231	Clear Cable Ties, 4.3 In. - Cynched	25	\$33.00
09239	Clear Cable Ties, 8.3 In. - Cynched	25	\$39.00
09246	Clear Cable Ties, 2.4 In. - Cynched Wide	25	\$19.00
09373	Clear Cable Ties, 4.3 In. - Cynched Wide	25	\$34.00
09282	Clear Cable Ties, 7.5 In. - Cynched Wide	25	\$45.00
09039	Clear Cable Ties, 11.8 In. - Flat	25	\$11.00
09139	Clear Cable Ties, 19.6 In. - Flat	25	\$18.00

LBK Weighing Scale

Code No	Description	Price
LBX 30	LBK Weighing Scales	\$280.00

Clamps & Spreaders

Code No	Description	Price
20407	Stainless Steel Instrument Spreader	\$30.60
20412	Stainless Steel Band Clamp W/Anti-Slide Covering-Green	\$30.60
20406	Stainless Steel Band Clamp W/Anti-Slide Covering-Red	\$30.60
20408	Stainless Steel Band Clamp W/Anti-Slide Covering-Blue	\$30.60
20411	Stainless Steel Band Clamp W/Anti-Slide Covering-Yellow	\$30.60

EasyStringer™



Code No	Color	Price
ES-100	6" Wide EasyStringer Base	\$72.55
ES-109	9" Wide EasyStringer Base	\$98.45
ES-112	12" Wide EasyStringer Base	\$114.00

Instrument Stringers

Code No	Description	Width	Rod Diameter	Length	Price
AJS 8	8" long x 2.5" - 5.5" wide				\$90.00
AJS 13	13" long x 2.5" - 5.5" wide				\$92.50
AJS 17	17" long x 2.5" - 5.5" wide				\$95.00
10-1770	Bunt Instrument Holder	1.50		5.25	\$21.00
IWC-001	Stainless Steel Wash Cradle	2.00	3.75	11.50	\$88.10
ST2.64C	Crescent Style	2.50	0.25	6.00	\$44.05
ST2.84C	Crescent Style	2.50	0.25	8.00	\$44.05
ST2.104C	Crescent Style	2.50	0.25	10.00	\$46.65
ST2.124C	Crescent Style	2.50	0.25	12.00	\$47.70
ST2.144C	Crescent Style	2.50	0.25	14.00	\$50.80
ST2.164C	Crescent Style	2.50	0.25	16.00	\$50.80
ST2.184C	Crescent Style	2.50	0.25	18.00	\$75.65
ST3-64C	Crescent Style	3.50	0.25	6.00	\$47.70
ST3-84C	Crescent Style	3.50	0.25	8.00	\$47.70
ST3-104C	Crescent Style	3.50	0.25	10.00	\$47.70
ST3-124C	Crescent Style	3.50	0.25	12.00	\$49.75
ST3-144C	Crescent Style	3.50	0.25	14.00	\$50.80
ST3-164C	Crescent Style	3.50	0.25	16.00	\$57.00
ST3-184C	Crescent Style	3.50	0.25	18.00	\$61.15
ST55-8	Pin Locking Stringer	5.50		8.00	\$55.00
ST-6	Pin Locking Stringer	2.75		6.00	\$45.00
HE8-0006	EZ Lok Double-Hinge Bar	2.50	0.19	6.00	\$71.50
HE8-0008	EZ Lok Double-Hinge Bar	2.50	0.19	8.00	\$74.65
HE8-0010	EZ Lok Double-Hinge Bar	2.50	0.19	10.00	\$80.85
HE8-0012	EZ Lok Double-Hinge Bar	2.50	0.19	12.00	\$85.00
HE8-0014	EZ Lok Double-Hinge Bar	2.50	0.19	14.00	\$87.05
HE8-0016	EZ Lok Double-Hinge Bar	2.50	0.19	16.00	\$95.35
HE2-0006	Hairpin Style, U-Shaped	2.50	0.19	6.00	\$36.30
HE2-0008	Hairpin Style, U-Shaped	2.50	0.19	8.00	\$40.45
USPRS-6	Spring Instrument Stringer	2.50	0.25	6.00	\$28.00
USPRS-8	Spring Instrument Stringer	2.50	0.25	8.00	\$29.00
USPRS-10	Spring Instrument Stringer	2.50	0.25	10.00	\$30.50
USPRS-12	Spring Instrument Stringer	2.50	0.25	10.00	\$32.25
USPRS-14	Spring Instrument Stringer	2.50	0.25	14.00	\$34.00
USPRS-16	Spring Instrument Stringer	2.50	0.25	16.00	\$36.25

Instrument Stringers

Code No	Description	Width	Rod Diameter	Length	Price
HE2-0010	Hairpin Style, U-Shaped	2.50	0.19	10.00	\$44.05
HE2-0012	Hairpin Style, U-Shaped	2.50	0.19	12.00	\$48.20
HE2-0014	Hairpin Style, U-Shaped	2.50	0.19	14.00	\$51.85
HE2-0016	Hairpin Style, U-Shaped	2.50	0.19	16.00	\$57.00
HE2-0018	Hairpin Style, U-Shaped	2.50	0.19	18.00	\$62.20
ST-064U	Hairpin Style, U-Shaped	2.50	0.25	6.00	\$31.10
ST-084U	Hairpin Style, U-Shaped	2.50	0.25	8.00	\$31.10
ST-104U	Hairpin Style, U-Shaped	2.50	0.25	10.00	\$31.10
ST-124U	Hairpin Style, U-Shaped	2.50	0.25	12.00	\$34.20
ST-144U	Hairpin Style, U-Shaped	2.50	0.25	14.00	\$36.30
ST-164U	Hairpin Style, U-Shaped	2.50	0.25	16.00	\$38.35
ST-184U	Hairpin Style, U-Shaped	2.50	0.25	18.00	\$42.50
ST3-06U	Hairpin Style, U-Shaped	3.50	0.19	6.00	\$26.95
ST3-08U	Hairpin Style, U-Shaped	3.50	0.19	8.00	\$26.95
ST3-10U	Hairpin Style, U-Shaped	3.50	0.19	10.00	\$26.95
ST3-12U	Hairpin Style, U-Shaped	3.50	0.19	12.00	\$29.05
ST3-14U	Hairpin Style, U-Shaped	3.50	0.19	14.00	\$31.10
ST3-16U	Hairpin Style, U-Shaped	3.50	0.19	16.00	\$33.20
ST3-18U	Hairpin Style, U-Shaped	3.50	0.19	18.00	\$37.35
ST3-064U	Hairpin Style, U-Shaped	3.50	0.25	6.00	\$31.10
ST3-084U	Hairpin Style, U-Shaped	3.50	0.25	8.00	\$31.10
ST3-104U	Hairpin Style, U-Shaped	3.50	0.25	10.00	\$31.10
ST3-124U	Hairpin Style, U-Shaped	3.50	0.25	12.00	\$34.20
ST3-144U	Hairpin Style, U-Shaped	3.50	0.25	14.00	\$36.30
ST3-164U	Hairpin Style, U-Shaped	3.50	0.25	16.00	\$38.35
ST3-184U	Hairpin Style, U-Shaped	3.50	0.25	18.00	\$42.50
ST5-064U	Hairpin Style, U-Shaped	5.00	0.25	6.00	\$33.20
ST5-084U	Hairpin Style, U-Shaped	5.00	0.25	8.00	\$33.20
ST5-104U	Hairpin Style, U-Shaped	5.00	0.25	10.00	\$33.20
ST5-124U	Hairpin Style, U-Shaped	5.00	0.25	12.00	\$37.35
ST5-144U	Hairpin Style, U-Shaped	5.00	0.25	14.00	\$39.40
ST5-164U	Hairpin Style, U-Shaped	5.00	0.25	16.00	\$41.45
ST5-184U	Hairpin Style, U-Shaped	5.00	0.25	18.00	\$46.65
HP6-12U	Hairpin Style, U-Shaped	6.00	0.19	12.00	\$41.45
10-1780	Saunders Instrument Rack	4.00		5.75	\$99.00
HE1-0006-W	Weinstein Instrument Holder	2.50		6.00	\$74.10
HE1-0008-W	Weinstein Instrument Holder	2.50		8.00	\$80.85

Instrument Stringers

Code No	Description	Width	Length	Price
HE1-0010-W	Weinstein Instrument Holder	2.50	10.00	\$84.50
HE1-0012-W	Weinstein Instrument Holder	2.50	12.00	\$88.10
HE1-0014-W	Weinstein Instrument Holder	2.50	14.00	\$93.30
HE1-0016-W	Weinstein Instrument Holder	2.50	16.00	\$96.40
HE1-0018-W	Weinstein Instrument Holder	2.50	18.00	\$99.50
10-1805	Weinstein Instrument Holder	3.00	11.25	\$105.00
10-1775	Weisenbach Instrument Forceps		6.00	\$99.00
10-1776	Weisenbach Instrument Forceps		13.50	\$99.00

Ultrasonic Cleaning Pouch

Code No	Description	Length	Width	Price
8001	Ultrasonic Cleaning Pouch	5.00	8.00	\$55.00
8002	Ultrasonic Cleaning Pouch	8.00	12.00	\$70.00
8003	Ultrasonic Cleaning Pouch	8.00	18.00	\$82.90

Washer Baskets

Code No	Description	Length	Width	Height	Price
75.0005.3	Wire Basket	9.500	9.875	2.000	\$145.00
75.0004.6	Wire Basket	9.500	9.875	2.750	\$135.00
75.0005.9	Wire Basket	18.875	9.875	2.000	\$220.00
75.0004.8	Wire Basket	18.875	9.875	2.750	\$220.00
75.0004.9	Wire Basket	18.875	9.875	4.000	\$220.00
75.0091.2	Cover	9.500	9.875		\$191.75
75.0091.1	Cover	18.875	9.875		\$191.75
72.1400.5	Large Washer Basket	23.667	15.750	4.000	\$255.00
72.1400.6	Large Washer Basket	23.667	15.750	7.875	\$265.00
NIC000	Round Nic-Nac Basket		3.000	3.000	\$110.00
NIC001	Round Nic-Nac Basket		4.000	1.250	\$155.45
21000-H	Hinged Parts Basket	3.000	1.000	1.000	\$69.00
NIC002	Nic-Nac Basket	7.000	5.000	1.000	\$155.45
NIC003	Nic-Nac Basket	7.000	9.000	1.000	\$176.20
NIC MICRO 1	Round Nic-Nac Basket w/Handle (3/pkg)	1.750			\$17.25
NIC MICRO 2A	Round Nic-Nac Basket (3/pkg)	2.000			\$17.10
NIC MICRO 2	Round Nic-Nac Basket (3/pkg)	2.500			\$20.25
NIC MICRO 3	Round Nic-Nac Basket (3/pkg)	3.000			\$20.75

Stainless Steel Washing Sleeves

Code No	Description	Qty	Price
07433	SS Washing Sleeve - 2.16 In (55 mm)	1	\$35.00
07436	SS Washing Sleeve - 8.66 In (220 mm)	1	\$139.00
07439	SS Washing Sleeve - 15.16 (385 mm)	1	\$243.00
07441	SS Washing Sleeve - 19.48 (495 mm)	1	\$313.00

Medical Grade Paper Bags

Code No	Description	Width	Length	Height	Case	Price
PB1	Paper Bags	3.50	6.00	2.00	1000	\$57.00
PB2	Paper Bags	4.00	7.00	1.00	1000	\$58.00
PB3	Paper Bags	4.70	10.00	2.00	1000	\$115.00
PB4	Paper Bags	5.50	10.00	3.00	1000	\$108.85
PB5	Paper Bags	5.50	13.00	2.00	500	\$60.00
PB7	Paper Bags	7.00	15.00	3.75	500	\$108.00
PB8	Paper Bags	7.50	13.00	2.50	500	\$63.00
PB9	Paper Bags	9.75	15.00	4.00	250	\$48.00
PB10	Paper Bags	11.75	20.75	3.00	250	\$74.00
PBR-15	7 pouches, 1.5" wide	10.00	14.00		100	\$38.35
PBR-35	4 pouches, 3.0" wide	10.00	14.00		100	\$32.00
PBTO	Time Out Bag	5.00	13.00	2.00	500	\$64.00

Leak Tester Tester

Code No	Description	Qty	Price
LTT4000	Leak Tester Tester - Set of 4	4	\$995.00
LTT-1001	Olympus Automated Leak Tester Tester	1	\$208.70
LTT-1002	Handheld Olympus Tester Tester	1	\$248.08
LTT-1003	Handheld Pentax Tester Tester	1	\$248.08
LTT-0004	Handheld Storz Tester Tester	1	\$248.08

Optical Products

Code No	Color	Price
26043	Pocket Magnifier	\$7.80
26106	OptiVisor	\$93.30
26501-DSG	Adjustable Arm Magnifier	\$285.00
26501-B22	Replacement Bulb for 26501-DSG	\$24.20
26505-SIV	WideView Magnifying Lamp	\$207.25
26505-B09	Replacement Bulb for 26505-SIV	\$12.45
26508-LED2	ProVue Touch LED Magnifying Lamp	\$409.35
MG10081-8	Pocket Microscope	\$20.00
MAG-002	LED 4x Magnifier	\$30.00
MICR007	USB mighty scope slim microscope w/aluminum stand	\$300.00
FIS-005SK	Flexible Inspection Scope Starter Kit 110cm length	\$7000.00
FIS-006SK	Flexible Inspection Scope Starter Kit 110cm length, 1.3mm dia	\$10,500.00
100657-K	Flexarm Kit	\$123.00
42400-4 RD	6" Round Red LED Magnifier	\$748.00
82400-4 BL	7" x 5.25" Retangular Blue LED Magnifier	\$935.00
DB-LM-20	4" DeskBrite LED Magnifier	\$45.00
MAG-310	Hand-held Multi-Magnifier 3x, 10x, 55x	\$10.00
RNDMAG-1	Magic Touch, LED, 3x Magnifier	\$49.00
RNDMAGSTND-1	Stand for RNDMAG-1	\$19.95

Washable Keybopard and Mouse

Code No	Color	Price
KBM-001	Washable Keyboard and Mouse	\$504.00
KB-001	Washable Keyboard	\$295.75
MOS-001	Washable Mouse	\$208.25