

FLEXISTEM Small Channel Cleaners

Code No	Description	Length	Dia. (mm)	Price
FLEX001	Soft Cleaner - Roll	40.0	3.0	\$10.10
FLEX002	Super Bristle - Roll	40.0	3.0	\$11.55
FLEX003	Double Clean Stem - 100 each	0.5	3.0	\$30.00
FLEX004	Fleece Stem - 50 each	1.0	9.0	\$27.50
FLEX005	Fleece Stem - 50 each	1.0	12.0	\$30.00
FLEX006	Bristle Stem - 20 each	1.0	15.0	\$20.00
FLEX007	Bristle Stem - Roll	20.0	15.0	\$18.00
FLEX007A	Wavy Stem - 20Ft Roll (3 mm - 15mm dia.)	15.0	20.0	\$18.00
FLEX008	Dispenser and 1 pack of each	0.0	0.0	\$299.00
FLEX009	Complete Refill Pack	0.0	0.0	\$150.00
FLEX033	Polypropylene Flexistem - 50 each	0.5	3.0	\$20.00

FLEXISTEM Ultra Channel Cleaners

Code No	Description	Length	Dia. (mm)	Price
FLEX021	Super Fine - Roll	6.0	3.0	\$16.00
FLEX022	Medium Fine - Roll	6.0	6.0	\$17.00
FLEX023	Super Brush - Roll	6.0	3.0	\$18.75
FLEX024	Medium Brush - Roll	6.0	6.0	\$20.00
FLEX025	Dispenser and 1 pack of each			\$199.00
FLEX026	Complete Refill Pack			\$70.00

ProSys™ Instrument Cleaning Brushes

Code No	Description	Overall Length	Inch Diameter	Millimeter Diameter	Brush Part (in.)	Qty	Price
CCBRK-1	Complete Brush Kit with Storage Rack					1	\$99.00
RPCBRK-1	Complete Brush Kit w/o Storage Rack					1	\$69.95
4030	Standard Tube Brush	6.25	0.25	6.00	2.00	1	\$1.58
4031	Standard Tube Brush	6.25	0.38	10.00	2.00	1	\$1.68
52003-35	For Verres Needles	8.00	0.05	1.35	1.00	12	\$59.75
4032	Standard Tube Brush	8.50	0.50	13.00	3.00	1	\$1.86
4033	Standard Tube Brush	8.50	0.63	16.00	3.00	1	\$1.93
4034	Standard Tube Brush	8.50	0.75	19.00	3.00	1	\$1.93
TR350109	Special Tube Brush	11.82	0.08	2.00	0.79	3	\$9.36
TR350232	Special Tube Brush	11.82	0.12	3.00	0.79	3	\$9.36
TR350233	Special Tube Brush	11.82	0.16	4.00	0.79	3	\$9.36
TR350354	Special Tube Brush	11.82	0.20	5.00	0.79	3	\$9.36

Code No	Description	Overall Length	Inch Diameter	Millimeter Diameter	Brush Part (in.)	Qty	Price
TR350429	Special Tube Brush	11.82	0.24	6.00	0.79	3	\$9.36
52003-21/S	For 3mm Trocar & 6mm Biopsy Tong	12.00	0.12	3.00	3.00	12	\$53.50
10-1660	Special Tube Brush	12.00	0.13	3.18	2.25	3	\$49.50
52003-25	For 8mm Trocar Sleeves	12.00	0.32	8.00	3.00	12	\$53.50
52003-27	For 10mm Trocar Sleeves	12.00	0.40	10.00	3.00	12	\$53.50
4035	Standard Tube Brush	12.50	1.00	25.00	4.00	1	\$2.81
4041	Standard Tube Brush	13.00	0.44	11.00	3.50	3	\$10.17
4036	Standard Tube Brush	13.00	1.25	32.00	4.00	1	\$2.96
4037	Standard Tube Brush	13.00	1.50	38.00	4.00	1	\$3.41
4038	Standard Tube Brush	13.00	1.75	44.00	4.00	1	\$4.77
4039	Standard Tube Brush	13.00	2.00	51.00	4.00	1	\$4.99
10-1664	Special Tube Brush	15.50	0.38	9.50	2.50	3	\$66.00
10-1668	Special Tube Brush	15.50	0.75	19.00	3.50	3	\$51.00
24-1-035	Cleaning Brush, White Nylon, 15 FR	16.00	0.19	4.82	2.50	6	\$48.00
24-1-040	Cleaning Brush, White Nylon, 18 FR	16.00	0.25	6.00	2.50	6	\$48.00
24-1-055	Cleaning Brush, White Nylon, 45 FR	16.00	0.28	15.00	2.50	6	\$48.00
24-1-046	Cleaning Brush, White Nylon, 33 FR	24.00	0.44	11.00	2.50	6	\$48.00
24-1-041	Cleaning Brush, White Nylon, 18 FR	24.00	0.25	6.00	2.50	6	\$48.00
24-1-045	Cleaning Brush, White Nylon, 33 FR	16.00	0.44	11.00	2.50	6	\$48.00
24-1-050	Cleaning Brush, White Nylon, 36 FR	16.00	0.48	12.00	2.50	6	\$48.00
24-1-007	Cleaning Brush, White Nylon, 3 FR	18.00	0.03	0.75	0.50	6	\$48.00
24-1-010	Cleaning Brush, White Nylon, 4.5 FR	18.00	0.06	1.50	0.50	6	\$48.00
24-1-015	Cleaning Brush, White Nylon, 5 FR	18.00	0.08	2.00	0.50	6	\$48.00
24-1-020	Cleaning Brush, White Nylon, 6.6 FR	18.00	0.09	2.25	0.50	6	\$48.00
24-1-025	Cleaning Brush, White Nylon, 8 FR	18.00	0.10	2.50	1.00	6	\$48.00
24-1-030	Cleaning Brush, White Nylon, 9 FR	18.00	0.13	3.30	1.00	6	\$48.00
52003-21	For 3mm Trocar & 6mm Biopsy Tong	19.00	0.12	3.00	3.00	12	\$53.50
52003-23	For 6mm Trocar Sleeves	19.00	0.12	3.00	3.00	12	\$53.50
52003-33	For 3mm Biopsy Tong	19.00	0.24	6.00	3.00	12	\$53.50
TR03020	Special Tube Brush	20.00	0.03	0.70	0.50	3	\$16.98
130-1/4	Special Tube Brush	21.00	0.25	6.40	4.00	3	\$14.04
130-3/8	Special Tube Brush	21.00	0.38	9.50	4.00	3	\$14.04
24-1-060	Cleaning Brush, White Nylon, 60 FR	16.00	0.80	20.00	2.50	6	\$48.00
4042	Standard Tube Brush	24.00	0.50	13.00	3.00	3	\$11.49
TR360231	Special Tube Brush	24.03	0.10	2.50	3.00	3	\$10.80
TR150221	Special Tube Brush	24.03	0.20	5.00	3.00	3	\$7.92
TR150483	Special Tube Brush	24.03	0.28	7.00	3.00	3	\$7.92
TR160617	Special Tube Brush	24.03	0.39	10.00	3.00	3	\$7.92

Toothbrush Style Brushes



Code No	Description	Length	Width	Trim	Price
200499	Double Brush/Stainless	7.00	0.50	0.50	\$5.00
200399	Double Brush/Nylon	7.00	0.50	0.50	\$4.25
200399-S	Double Ended Brush - Packaged Sterile, 20 each	7.00	5.00	0.50	\$120.00
C-1002	brass (pack of 3 brushes)	7.75	1.50	0.50	\$17.75
3182-P	stainless	7.75	1.50	0.50	\$1.15
3181-P	nylon	7.75	1.50	0.50	\$1.15
221 SN	nylon & stainless	7.75	1.50	0.50	\$4.50

Block Style Brushes

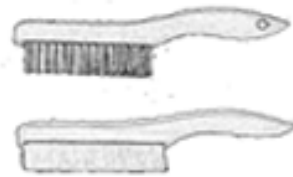

Code No	Description	Length	Width	Trim	Price
869903N	nylon	2.50	3.00	1.25	\$5.95
3090	stainless	10.00	1.00	1.25	\$8.79
4007	nylon	10.00	1.00	1.25	\$7.95
GDS-1	nylon, w/ surgical nail brush	4.00	1.60	0.50	\$1.70
GDS-2	nylon	4.10	1.60	0.50	\$1.75

Bipolar Forceps Cleaner



Code No	Description	Price
DIA001	Bipolar Forcep Set - Stainless	\$28.50

Reamer Brushes



Code No	Description	Length	Width(mm)	Trim	Price
3770	Trumpet Valve Brush (6.375mm & 1mm)	12.00	1.00	6.38	\$2.25
RB300105	Reamer Brush	30.00	1.25	5.00	\$16.50
RB310306	Reamer Brush	31.00	3.00	6.00	\$19.95
RB310307	Reamer Brush	31.00	3.00	7.00	\$19.95

Flexible Endoscope Brushes



Code No	Description	Dia. (mm)	Length (cm)	Trim (mm)	Price
007-601	Standard Colonoscope/ Duodoscope	1.7	230	6	\$2.50
007-603	Jumbo Colonoscope/ Duendoscope	1.7	230	9	\$2.50
00711610	Control Head/Valve Cleaning Brush	1.0	4	10	\$6.00
CC-110	Clear Channel Brush	1.2	65	0	\$8.50
CC-250	Clear Channel Brush (2.8 - 3.7 mm)	2.8	250	0	\$116.25

Brush Cleaning Tools



Code No	Description	Price
BR001	Brush Storage Rack	\$54.00
BRS03	Brush Soaking Tray	\$72.00

Prerinse Shower Unit

Code No	Description	Price
300718	Deck Mounted Spray Unit	\$978.00
300719	Splash Mounted Spray Unit	\$981.00
301189	Faucet Add-on with 12" Spout	\$260.00
301190	Wall Bracket	\$66.00
313116	Pre-Rinse Hose 36" Length	\$186.00
313323	Pre-Rinse Spray Valve Assembly	\$161.00

Spray Guns

Code No	Description	Price
80-10-01	Spray Gun only	\$205.00
80-10-70-05	Spray Gun with plastic hose & 3/4" connector. Includes 1.5 meter hose (58 inches), 80-01-05 spray tip and wall hook	\$305.00
80-10-70-38	Spray Gun w/ 1.5 meter hose, 3/4" connector & complete tip set & rack	\$515.00
80-10-72-05	Spray Gun with plastic hose & 3/4" connector. Includes: 3 meter hose (117 inches), 80-01-05 spray tip and wall hook	\$340.00
80-00-17	Table-top Rosette	\$71.50
80-00-44	Replacement Kit - Flow Control	\$46.50
80-10-14	Plumbing 3/4" connector	\$25.50
80-10-15	Plumbing 1/2" connector	\$25.50
80-01-05	Universal Tip	\$21.50
80-01-06	For drainage tube	\$21.50
80-01-08	Spray jet for rinsing out glassware, etc.	\$21.50
80-01-38	Tip attachments - complete set of all 8 sizes	\$285.00
80-10-40	For syringes and cannulae with record cone	\$21.50
80-10-41	For measuring and blood pipettes	\$21.50
80-10-42	For syringes and cannulae with Luer cone	\$21.50
80-10-43	For bottles and Erlenmeyer flasks	\$38.50
80-10-44	Water jet pump for suction	\$65.00
80-10-12	"O" Rings, 10 per package	\$3.00

Sterigard™
 Tip
 Protectors

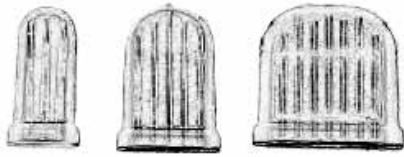

Code No	Dia. (mm)	Height (mm)	Width (mm)	Case	Price
10001	1.6	19.0		100	\$16.50
10002	1.9	19.0		100	\$16.50
10003	2.7	19.0		100	\$16.50
10004	3.2	25.0		100	\$16.50
10005	4.7	25.0		100	\$16.50
10006	10.5	19.0		100	\$16.50
10007	1.6	9.5	25.0	100	\$16.50
10008	1.6	16.0	25.0	100	\$16.50
10009	3.2	25.0	25.0	100	\$16.50
10010	6.3	19.0		100	\$16.50

Economical Single-Use
 Tip Protectors



Code No	Case Qty	Slot Dia. (mm)	Price
PPT001	2000/box, paper	15	\$155.00
PPT002	1000/box, paper	15	\$82.50
PPT003	2000/box, paper	30	\$155.00
PPT004	1000/box, paper	30	\$82.50
PPT005	2000/box, paper	5	\$155.00
PPT006	1000/box, paper	5	\$82.50
PPT007C	200/box, plastic	15	\$25.00
PPT008C	200/box, plastic	30	\$25.00

Vented Instrument Guards

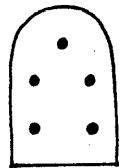

Opaque Code No	Color	Width (inch)	Height (inch)	Dia. (inch)	Case	Price	Clear Code No	Color	Price
09-1-011	White	0.06	0.75		100	\$21.50	09-2-011	Clear	\$21.50
09-1-012	Blue	0.08	0.75		100	\$21.50	09-2-012	Clear	\$21.50
09-1-013	Green	0.11	0.75		100	\$21.50	09-2-013	Clear	\$21.50
09-1-014	Red	0.13	1.00		100	\$21.50	09-2-014	Clear	\$21.50
09-1-015	Yellow	0.19	1.00		100	\$21.50	09-2-015	Clear	\$21.50
09-1-016	Maroon	0.41	0.75		100	\$21.50	09-2-016	Clear	\$21.50
09-1-017	Orange	0.06	0.38	1.00	100	\$21.50	09-2-017	Clear	\$21.50
09-1-018	Brown	0.08	0.63	1.00	100	\$21.50	09-2-018	Clear	\$21.50
09-1-019	Black	0.13	1.00	1.00	100	\$21.50	09-2-019	Clear	\$21.50
09-1-020	Asst. Colors & Sizes	0.00	0.00	0.00	100	\$21.50	09-2-020	Asst. Sizes - Clear	\$21.50

Duo-Vented
 Instrument Guards

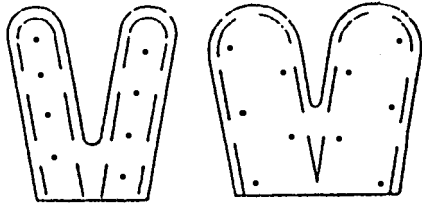

Code No	Color	Height (inch)	Width (inch)	Dia. (inch)	Case	Price
09-3-031	White Tint	0.06	0.75		50	\$26.00
09-3-032	Blue Tint	0.08	0.75		50	\$26.00
09-3-033	Green Tint	0.11	0.75		50	\$26.00
09-3-034	Red Tint	0.13	1.00		50	\$26.00
09-3-035	Yellow Tint	0.19	1.00		50	\$26.00
09-3-037	Orange Tint	0.06	0.38	1.00	50	\$26.00
09-3-040	For Veress Needles.	0.75			50	\$31.25

Cylindrical Style Instrument Guards

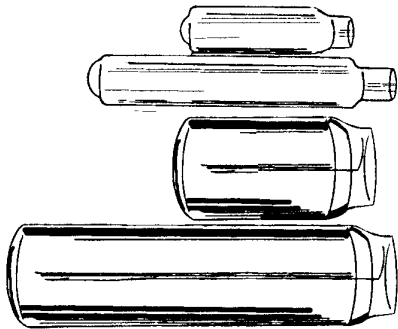

Code No	Description	Length	Dia. (mm)	Qty	Price
09-7-011	For Veress Needles	0.80	5.00	50	\$14.25
09-7-012	For all 5mm Instruments, trocars, Probes, etc.	1.68	5.00	25	\$14.00
09-7-013	For all 10mm Instruments, trocars, Probes, etc.	0.80	10.00	20	\$14.00
09-7-014	For all 10mm Instruments, trocars, Probes, etc.	2.25	10.00	25	\$14.00
09-7-015	For all 10mm Instruments, trocars, Probes, etc.	2.25	5.00	20	\$14.00

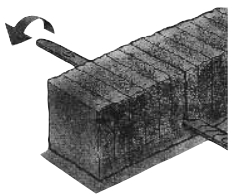

Foam Tray Anchors

Code No	Description	Price
ANC001	Pack of 16 strips	\$89.50
ANC002	Pack of 64 strips	\$249.00

Plasma-Cel™ Instrument Foam Protection for Plasma Sterilizers

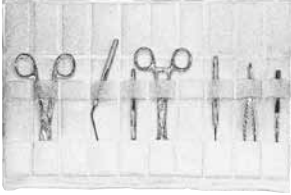

Code No	Description	Width	Length	Case	Price
PC4600	Roll	12.00	72.00	3	\$69.95
PC4800	Precut Sheets	12.00	10.00	50	\$125.00
PC4850	Precut Sheets	12.00	16.00	25	\$100.00
PC4880	Precut Sheets	12.00	20.00	25	\$145.00
PC5200	Pocket w/ Belts	11.00	15.50	10	\$90.00
PC5500	Multi-Pouch	13.00	17.00	10	\$100.00
PC6200	Rigid Scope Pouch	2.00	20.00	50	\$137.50
PC6210	Large Single Pouch	4.00	7.00	50	\$142.50
PC6250	Small Single Pouch	2.10	7.50	50	\$49.50

Steri-Cel™ Instrument Foam Protection for Steam and EtO

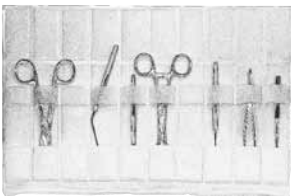

Code No	Description	Width	Length	Case	Price
SC4600	Roll	12.00	108.00	3	\$48.66
SC4800	Precut Sheets	12.00	10.00	50	\$36.00
SC4850	Precut Sheets	12.00	16.00	25	\$29.00
SC4880	Precut Sheets	12.00	20.00	25	\$48.00
SC5200	Pocket w/ Belts	11.00	15.00	10	\$48.50
SC5500	Multi-Pouch	13.00	17.00	10	\$77.50
SC6200	Rigid Scope Pouch	2.00	20.00	50	\$168.00
SC6210	Large Single Pouch	4.00	7.00	50	\$120.00
SC6214	Large Flared Scope Pouch	3.25	1.75	25	\$110.00
SC6250	Small Single Pouch	2.10	7.50	50	\$37.50
SC6270	Camera/Fiber-Optic Cable	9.50	10.00	10	\$72.50
SC6314	Small Flared Scope Pouch	3.63	1.75	25	\$96.66



Instrument Repair Tags

Code No	Description	Width
5030 WHITE "CLEAN"	White Pulltight - "Clean"	\$25.00
994-G	Green - Good	\$17.50
994-R	Red - Repair	\$17.50
994-S	Yellow - Sharpen	\$17.50

Latex Scissor Test

Code No	Length	Width	Gauge	Qty	Price
LT-130	5.00	5.00	6.00	10	\$20.00
YT606	216.00	5.50	6.00	1	\$16.50
RT608	216.00	5.50	8.00	1	\$17.63

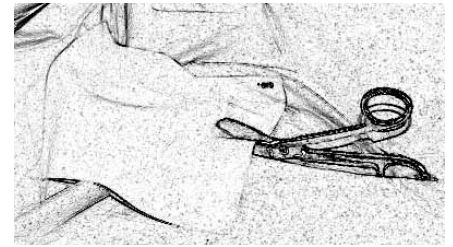

Pro-Ties™ Bundling System

Code No	Color	Price
310-054	Yellow	\$25.00
310-053	Blue	\$25.00
310-052	Green	\$25.00
310-051	Red	\$25.00



Insulated Gloves

Code No	Description	Length	Price
75574	Insulated Gauntlet (pair)	17.00	\$11.50
75524	Insulated Gauntlet (pair)	24.00	\$16.50
73224	Insulated Gauntlet (pair)	13.00	\$11.00
JB-2636	Seamless Autoclave Gloves	12.50	\$10.50
SLG-002	Shark Tooth Heat Mitt (each)	17.00	\$60.00
SLG-001	Shark Tooth Heat Mitt (each)	14.00	\$30.00
JB-422-5	Terry Cloth Autoclave Gloves (pair)	5.00	\$11.00
JB-422-11	Terry Cloth Autoclave Gloves (pair)	11.00	\$9.50



HotSpot Safe-to-Touch Indicators

Code No	Qty	Price
HS-101	50	\$95.00

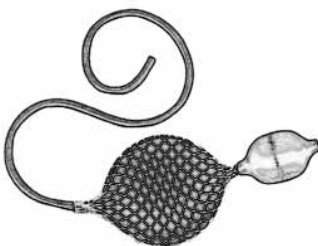

Disposable Bulb & Bladder

Code No	Description	Qty	Price
D30200-210	CLEAN (non-sterile) Disposable Bulb & Bladder Assembly	4	\$100.00
D30200-210S	STERILE Disposable Bulb & Bladder Assembly	5	\$150.00

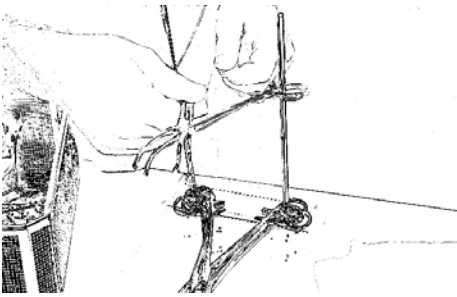

EasyStringer™

Code No	Color	Price
ES-100	6" Wide EasyStringer Base	\$62.00
ES-109	9" Wide EasyStringer Base	\$85.00
ES-112	12" Wide EasyStringer Base	\$100.00

Instrument Stringers

Code No	Description	Width	Rod Diameter	Length	Price
10-1770	Bunt Instrument Holder				\$15.00
IWC-001	Stainless Steel Wash Cradle	2.00	3.75	11.50	\$85.00
ST2-64C	Crescent Style	2.50	0.25	6.00	\$42.50
ST2-84C	Crescent Style	2.50	0.25	8.00	\$42.50
ST2-104C	Crescent Style	2.50	0.25	10.00	\$45.00
ST2-124C	Crescent Style	2.50	0.25	12.00	\$46.00
ST2-144C	Crescent Style	2.50	0.25	14.00	\$49.00
ST2-164C	Crescent Style	2.50	0.25	16.00	\$56.50
ST2-184C	Crescent Style	2.50	0.25	18.00	\$73.00
ST3-64C	Crescent Style	3.50	0.25	6.00	\$46.00
ST3-84C	Crescent Style	3.50	0.25	8.00	\$46.00
ST3-104C	Crescent Style	3.50	0.25	10.00	\$46.00
ST3-124C	Crescent Style	3.50	0.25	12.00	\$48.00
ST3-144C	Crescent Style	3.50	0.25	14.00	\$49.00
ST3-164C	Crescent Style	3.50	0.25	16.00	\$55.00
ST3-184C	Crescent Style	3.50	0.25	18.00	\$59.00
ES-100	6" Wide EasyStringer Base	6.00			\$62.00
ES-109	9" Wide EasyStringer Base	9.00			\$85.00
ES-112	12" Wide EasyStringer Base	12.00			\$100.00
HE8-0006	EZ Lok Double-Hinge Bar	2.50		6.00	\$69.00
HE8-0008	EZ Lok Double-Hinge Bar	2.50		8.00	\$72.00
HE8-0010	EZ Lok Double-Hinge Bar	2.50		10.00	\$78.00
HE8-0012	EZ Lok Double-Hinge Bar	2.50		12.00	\$82.00
HE8-0014	EZ Lok Double-Hinge Bar	2.50		14.00	\$84.00
HE8-0016	EZ Lok Double-Hinge Bar	2.50		16.00	\$92.00
HE8-0018	EZ Lok Double-Hinge Bar	2.50		18.00	\$96.00
HE2-0006	Hairpin Style, U-Shaped	2.50		6.00	\$35.00
HE2-0008	Hairpin Style, U-Shaped	2.50		8.00	\$39.00

Instrument Stringers

Code No	Description	Width	Rod Diameter	Length	Price
HE2-0010	Hairpin Style, U-Shaped	2.50		10.00	\$42.50
HE2-0012	Hairpin Style, U-Shaped	2.50		12.00	\$46.50
HE2-0014	Hairpin Style, U-Shaped	2.50		14.00	\$50.00
HE2-0016	Hairpin Style, U-Shaped	2.50		16.00	\$55.00
HE2-0018	Hairpin Style, U-Shaped	2.50		18.00	
ST-064U	Hairpin Style, U-Shaped	2.50	0.25	6.00	\$30.00
ST-084U	Hairpin Style, U-Shaped	2.50	0.25	8.00	\$30.00
ST-104U	Hairpin Style, U-Shaped	2.50	0.25	10.00	\$30.00
ST-124U	Hairpin Style, U-Shaped	2.50	0.25	12.00	\$33.00
ST-144U	Hairpin Style, U-Shaped	2.50	0.25	14.00	\$35.00
ST-164U	Hairpin Style, U-Shaped	2.50	0.25	16.00	\$37.00
ST-184U	Hairpin Style, U-Shaped	2.50	0.25	18.00	\$41.00
ST3-06U	Hairpin Style, U-Shaped	3.50	0.19	6.00	\$26.00
ST3-08U	Hairpin Style, U-Shaped	3.50	0.19	8.00	\$26.00
ST3-10U	Hairpin Style, U-Shaped	3.50	0.19	10.00	\$26.00
ST3-12U	Hairpin Style, U-Shaped	3.50	0.19	12.00	\$28.00
ST3-14U	Hairpin Style, U-Shaped	3.50	0.19	14.00	\$30.00
ST3-16U	Hairpin Style, U-Shaped	3.50	0.19	16.00	\$32.00
ST3-18U	Hairpin Style, U-Shaped	3.50	0.19	18.00	\$36.00
ST3-064U	Hairpin Style, U-Shaped	3.50	0.25	6.00	\$30.00
ST3-084U	Hairpin Style, U-Shaped	3.50	0.25	8.00	\$30.00
ST3-104U	Hairpin Style, U-Shaped	3.50	0.25	10.00	\$30.00
ST3-124U	Hairpin Style, U-Shaped	3.50	0.25	12.00	\$33.00
ST3-144U	Hairpin Style, U-Shaped	3.50	0.25	14.00	\$35.00
ST3-164U	Hairpin Style, U-Shaped	3.50	0.25	16.00	\$37.00
ST3-184U	Hairpin Style, U-Shaped	3.50	0.25	18.00	\$41.00
ST5-064U	Hairpin Style, U-Shaped	5.00	0.25	6.00	\$32.00
ST5-084U	Hairpin Style, U-Shaped	5.00	0.25	8.00	\$32.00
ST5-104U	Hairpin Style, U-Shaped	5.00	0.25	10.00	\$32.00
ST5-124U	Hairpin Style, U-Shaped	5.00	0.25	12.00	\$36.00
ST5-144U	Hairpin Style, U-Shaped	5.00	0.25	14.00	\$38.00
ST5-164U	Hairpin Style, U-Shaped	5.00	0.25	16.00	\$40.00
ST5-184U	Hairpin Style, U-Shaped	5.00	0.25	18.00	\$45.00
HP6-12U	Hairpin Style, U-Shaped	6.00	0.19	12.00	\$40.00
10-1780	Saunders Instrument Rack	4.00		5.75	\$60.00
HE1-0006-W	Weinstein Instrument Holder	2.50		6.00	\$71.50
HE1-0008-W	Weinstein Instrument Holder	2.50		8.00	\$78.00

Instrument Stringers

Code No	Description	Width	Rod Diameter	Length	Price
HE1-0010-W	Weinstein Instrument Holder	2.50		10.00	\$81.50
HE1-0012-W	Weinstein Instrument Holder	2.50		12.00	\$85.00
HE1-0014-W	Weinstein Instrument Holder	2.50		14.00	\$90.00
HE1-0016-W	Weinstein Instrument Holder	2.50		16.00	\$93.00
HE1-0018-W	Weinstein Instrument Holder	2.50		18.00	\$96.00
10-1800	Weinstein Instrument Holder	3.00		5.50	\$75.00
10-1805	Weinstein Instrument Holder	3.00		11.25	\$80.00
10-1775	Weisenbach Instrument Forceps			6.00	\$75.00
10-1776	Weisenbach Instrument Forceps			13.50	\$75.00

Washer Baskets

Code No	Description	Length	Width	Height	Price
75.0005.3	Wire Basket	9.500	9.875	2.000	\$99.00
75.0004.6	Wire Basket	9.500	9.875	2.750	\$97.00
75.0005.9	Wire Basket	18.875	9.875	2.000	\$160.00
75.0004.8	Wire Basket	18.875	9.875	2.750	\$160.00
75.0004.9	Wire Basket	18.875	9.875	4.000	\$160.00
75.0091.2	Cover	9.500	9.875		\$185.00
75.0091.1	Cover	18.875	9.875		\$185.00
72.1400.5	Large Washer Basket	23.667	15.750	4.000	\$165.00
72.1400.6	Large Washer Basket	23.667	15.750	7.875	\$172.00
NIC000	Round Nic-Nac Basket		3.000	3.000	\$88.00
NIC001	Round Nic-Nac Basket		4.000	1.250	\$150.00
21000-H	Hinged Parts Basket	3.000	1.000	1.000	\$49.50
NIC002	Nic-Nac Basket	7.000	5.000	1.000	\$150.00
NIC003	Nic-Nac Basket	7.000	9.000	1.000	\$170.00
NIC MICRO 1	Round Nic-Nac Basket (3/pkg)	1.750			\$15.00
NIC MICRO 2A	Round Nic-Nac Basket (3/pkg)	2.000			\$16.50
NIC MICRO 2	Round Nic-Nac Basket (3/pkg)	2.500			\$18.00
NIC MICRO 3	Round Nic-Nac Basket (3/pkg)	3.000			\$20.00

Paper Bags

Code No	Description	Width	Length	Height	Case	Price
PB1	Paper Bags	3.50	6.00	2.00	1000	\$52.44
PB2	Paper Bags	4.00	7.00	1.00	1000	\$53.33
PB3	Paper Bags	4.70	10.00	2.00	1000	\$72.00
PB4	Paper Bags	5.50	10.00	3.00	1000	\$105.00
PB5	Paper Bags	5.50	13.00	2.00	500	\$55.00
PB7	Paper Bags	7.00	15.00	3.75	500	\$98.80
PB8	Paper Bags	7.50	13.00	2.50	500	\$57.14
PB9	Paper Bags	9.75	15.00	4.00	250	\$43.68
PB10	Paper Bags	11.75	20.75	3.00	250	\$67.86
PBR-15	7 pouches, 1.5" wide	10.00	14.00		100	\$37.00
PBR-35	4 pouches, 3.0" wide	10.00	14.00		100	\$30.00
PBTO	Time Out Bag	5.00	13.00	2.00	500	\$58.44
PBR-76	Count Sheet Holder	7.50	3.00		1000	\$300.00

Optical Products

Code No	Color	Price
26043	Pocket Magnifier	\$7.50
26501-DSG	Fully Enclosed Spring-Free Arm Magnifier	\$275.00
26505-SIV	WideView Magnifying Lamp	\$200.00
26506-SIV	Tilt Lens Magnifying Lamp	\$210.00
26700-200	1.3 Megapixel USB Microscope Camera	\$375.00
26700-206	Polarized USB Microscope Camera	\$375.00
26700-300	Exceptional Value USB Microscope	\$150.00
26700-520	All-in-One Microscope Camera	\$875.00
FS1-504	Fiberscope, 1mm x 504mm and handheld lightsource	\$3,000.00
FS-CAM	USB Camera for fiberscope	\$2,000.00