

Brand Name of Product	SeekNFind™
Generic Name of Product	RFID Tray Tag and Reader
Product Code Number(s)	SNF-001, RFID-099, RFRD-001
Intended Use	The tag provides identification and tracking capabilities for trays and other assets.
Range of Applications for Product	The tray tag provides identification and tracking capabilities. The RFID reader can be used as a standalone or paired with a Bluetooth® technology enabled device such as a mobile computer and/or smartphone.
Key Specifications of Product	<p>RFID Tray Tag</p> <ul style="list-style-type: none"> ● Operating Temperature: -50 °C (-58 °F) to +250 °C (482 °F) ● Operational frequency: Standard: UHF MHz (EU), 902-928 MHz (US) ● EPC memory-UHF Standard: 128 bit ● Extended memory-UHF Standard: 512 bit ● TID-UHF Factory-programmed, non-changeable, unique 64 bit ID ● Tag material: PTFE Teflon ● Diameter of eyelet: 24 mm (0.95 inches) ● Tag Body Diameter: L 190 mm (7.5 inches) x W 7.86 mm (0.31 inches) ● Overall Length: 240 mm (9.5 inches) ● Max read-range on metal- 660.4 cm/ 260 inches (6.63 m/21.75 feet) ● Read range will be shorter when contained in a closed container/cart <p>RFID Reader</p> <ul style="list-style-type: none"> ● 4410 mAh Lithium-ion Battery ● Micro USB Cable ● Lanyard ● Quick Start Guide ● Regulatory Guide <p>RFID Software -SeekNFind™ App Compatibility The application is compatible with all Android Devices having Android Version 5.0 and up.</p>

Shipping & Storage	
Shipping Conditions & Requirements	N/A
Storage Conditions	<ul style="list-style-type: none"> ● Store batteries half charged in a dry, cool place between 41° and 77 °F (5 ° and 25 °C). ● Do not store the device with the battery installed.
Packaging Contents	N/A
Shelf Life	N/A

Instructions for Using Product	
Description of Use(s)	To track trays and other assets.
Preparation for Use	<p>Tray Tag</p> <ol style="list-style-type: none"> 1. The RFID tray tag is attached to the side of the instrument tray. This should be done using the facility's own attachments to secure the tray tag to the instrument tray. 2. The attachments will be placed through the eyelets at each end of the tray tag. <p>Fig. 1</p> <ol style="list-style-type: none"> 3. Secure the attachments to the instrument tray. Fig. 2 <p>Note: Stainless Rings #RIN001 is available for purchase.</p> <p>RFID Reader</p> <ol style="list-style-type: none"> 4. To install the battery, depress both battery cover release buttons. Fig. 3 5. Slide back and remove the battery cover. Fig. 4

6. Align the three tabs on the bottom of the battery with the three slots in the battery compartment. **Fig. 5**
7. Press the battery down and rotate down until it locks into place. **Fig. 6**
8. Replace the battery cover by placing the cover over the battery and sliding it forward until it clicks in place. **Fig. 7**
9. Charge the battery until the LED Power/Charging Indicator turns solid green.
10. To charge, use the Micro USB cable, connect the USB cable into the back of the RFID reader. and plug into the computer. **Fig. 8**
11. Press the POWER button to turn on the RFID reader.
12. Pair the RFID reader over Bluetooth with a mobile device.
13. Install the appropriate applications: Zebra RFID Mobile or the partner application.
14. Set the region and power level.

Removing the Battery

15. To remove the battery, power off the RFID reader.
16. Remove the battery cover and with two fingers, press the battery down. **Fig. 9**
17. Rotate the battery up out of the compartment. **Fig. 10**
18. Replace the battery cover and press the POWER button on.

Installing the Lanyard

19. To install the lanyard, loop on the lanyard into the slot at the bottom of the RFID handle.
20. Thread the upper portion of the lanyard into the loop. **Fig. 11**
21. Pull the clip through the loop over the tether point and tightened into place. **Fig.12**

Downloading Mobile Application for Android

22. Tap on Play Store app on the mobile phone.
23. In the search bar at the top type in SeekNFind™.
24. Tap on the app to start downloading.
25. Once the app has downloaded to the phone contact Healthmark Customer Care at healthmark@hmark.com to set up your account and get your username and password.
26. During the set up you can also customize your Site Information, Core Information, Service Information.
27. Once you have a username and password tap on the Healthmark app and type in the credentials.

Using Buttons and the Scan Trigger

28. Start/Stop RFID Tag Read- Scan Trigger
29. Start/Stop Bar Code Scan- Scan Trigger
30. Turn RFID Reader ON/OFF- Hold the Power button for three seconds to turn the RFID reader OFF. Press the Power button again to turn the RFID Reader ON.
31. RFID Reader/Bar Code Scanner Toggle- Press the Mode button to toggle scan trigger control between RFID tag reading and bar-code scanning. This function is only available on readers with an imager.
32. Enable Bluetooth- Hold the **Bluetooth** button for one second to turn on the Bluetooth discovery.
33. Disconnect Bluetooth- When connected with a mobile device, hold the button for one second to disconnect from the current device and return it to discovery mode to connect with another device.
34. Turn Off Bluetooth- Hold the button for five seconds to turn off Bluetooth.
35. Soft Reset the RFID Reader- Hold the **Mode** and **Bluetooth** buttons simultaneously for three seconds, then release to initiate the reset process.
36. Reset Device to Factory Defaults- Hold the **Power** and **Bluetooth** buttons simultaneously for five seconds, then release to initiate the factory reset process.

Led and Beeper Indicators

37. The LED and beeper indicators provide an indication of the operating statuses on the RFID reader. See table below.

38. Low battery at 20%- LED light is a solid amber and no beep.
39. Lower battery life at 10%- LED light is a solid red with short beeps- repeated.
40. Suspend- LED is a solid red, then it turns off with a high/medium/low beeps.
41. Charging battery- LED light is blinking amber with short beep when charger is connected.
42. Charged battery- LED light is solid green with one beep.
43. Charging error- LED is a fast blinking red light, with three beeps.
44. Power on-
 Light is Green if battery charge is >20%
 Amber if battery is between 10-20%
 Red if battery is <10%
 Beeps are Low/medium/high
 RFID mode- LED is Off with short high button confirmation beep
 Bar-code mode- LED is a solid green with short high button confirmation beep

Features on the RFID reader-

Left and Right-Side Views with Feature Descriptions 1-12:

1. Mode Button- Press to toggle between RFID and barcode modes (applicable to readers with a scanner). This button controls whether pressing the scan trigger button enables RFID or barcode function.
- Press Mode and Bluetooth buttons simultaneously for three seconds to perform a soft reset. The default mode is RFID.
2. Mode Indicator- Indicates the current mode of the reader.
 - LED on (green) - Barcode mode
 - LED off - RFID mode
3. Beeper- Sound beeps that reflect the state of the RFID reader.
4. Bluetooth Button- Turns Bluetooth on and off and enables discover mode.
5. Bluetooth Indicator- Indicates the Bluetooth status.
6. USB Port/Cover- USB port.
7. Power Button- Turns the RFID reader on and off.
8. Power Indicator- Reflects the power state of the RFID reader.
9. Battery Cover Release Buttons- Depress buttons to remove the battery cover.
10. Imager Window (units with imager only)- Scan/read window.
11. Scan Trigger- Press to scan barcodes or read tags.
12. RFID Antenna- Houses RFID antenna.

Left and Right-Side Views



Number 1-5

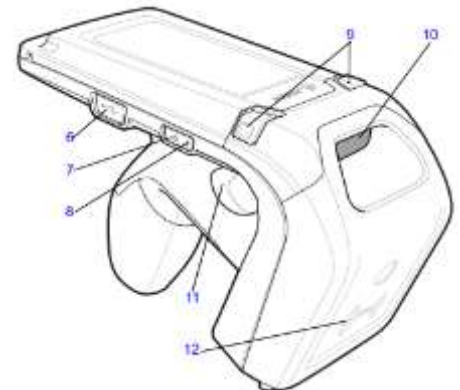

Number 6-12

Front and Back Views with Feature Descriptions 13-15:

1. Charging Contacts- Connects to a charging accessory.
2. Bar-code/RFID Indicator- Lights to reflect the status of decoding bar-codes/reading RFID tags.
3. Lanyard Slot- Used to install the lanyard.

Front and Back Views

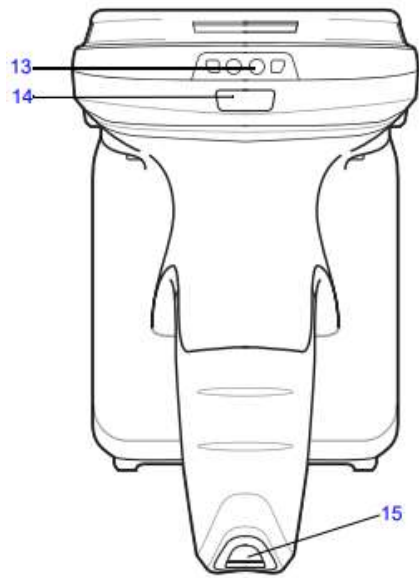

Number 13-15

Diagrams (drawings, pictures)



Figure 1



Figure 2



Figure 3

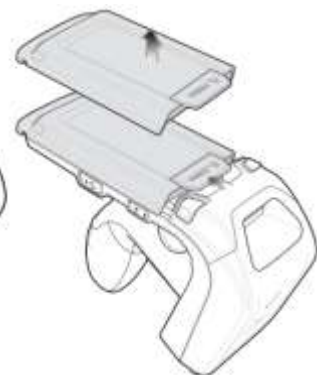

Figure 4

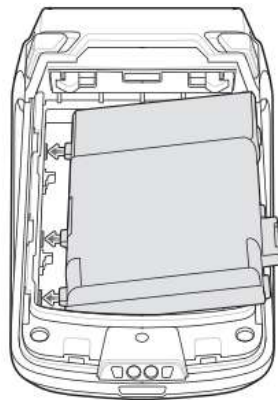

Figure 5

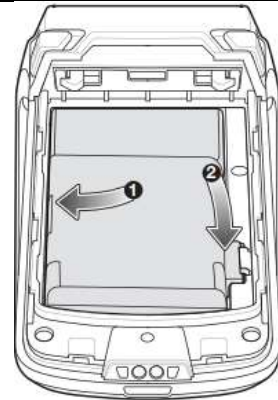

Figure 6

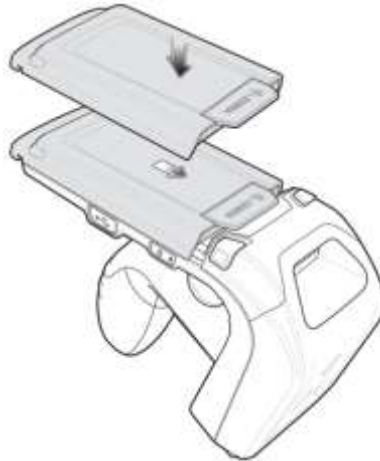

Figure 7

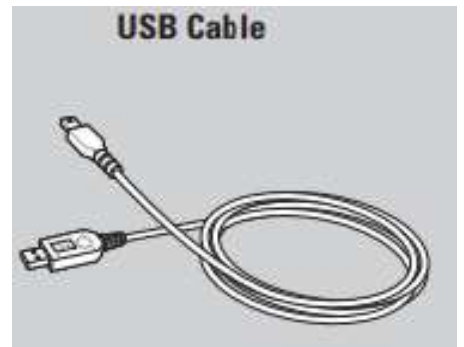

Figure 8

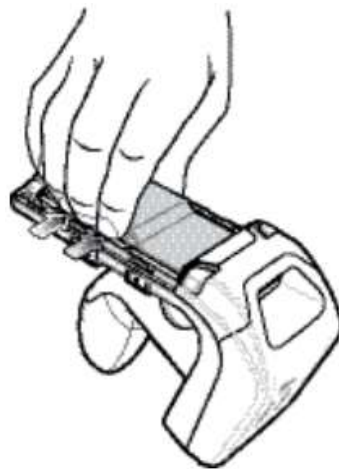

Figure 9

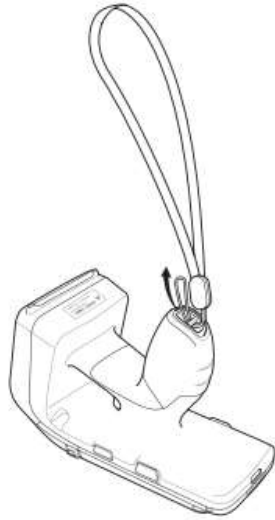

Figure 10

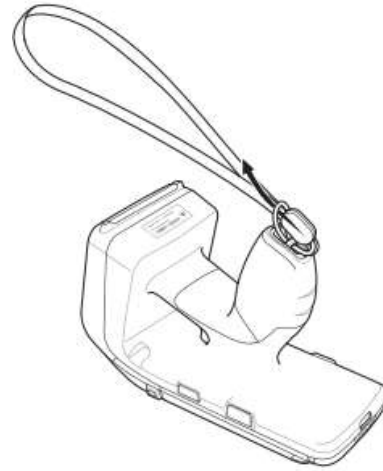

Figure 11

Figure 12

Steps for Use of Product

1. Power on the RFID reader located on the right side. **Fig. 1**



Figure 1

2. Pairing with the RFID reader is completed from the Android via Bluetooth *Settings* on the mobile device.

To pair with an Android device such as the Android Galaxy S5 Active:

1. Power on the Android phone.
2. Touch the *Settings* icon on the mobile device.
3. Turn Bluetooth on. **Fig. 2**



Figure 2

1. Touch *Search for Devices* to display the available discoverable devices.
2. Turn the RFID on and ensure Bluetooth is enabled by pressing the Bluetooth button on the side for one second to make it discoverable. When discoverable, the Bluetooth LED flashes blue.

NOTE: The RFID reader is discoverable over Bluetooth for 40 seconds after startup. After that time Bluetooth suspends and is no longer discoverable. To restart discovery, press the Bluetooth button for one second.

3. When the RFID reader displays in the list of available discoverable devices, tap the RFID reader device in the list and press the RFID trigger to pair when the Bluetooth Led starts flashing fast. A beep sounds when pairing is successful.
4. Exit the *Device Settings* screen and run the application.
5. From the application, select *Settings>Readers List* and confirm that the RFID reader serial number you paired with is displayed. Select it in the list of Available readers. This connects the RFID reader to the mobile device.

To use the Pairing/Locate Device Barcode

9. This appears on the RFID reader under the antenna compartment.
10. When you pair several RFID devices with your mobile device via Bluetooth, use the serial number represented by the Locate Device barcode to identify a specific paired RFID reader.

Using the Healthmark SeekNFind App:

Tap on the Healthmark SeekNFind app and type in the login name and password. **Fig. 3**



Figure 3

1. Once logged in tap on the 'Menu' at the top right corner of the screen. This will show the list of features available. **Fig. 4**



Figure 4

If the mobile phone and the RFID Reader were not paired in Settings on the mobile phone, tap on RFID Reader to pair with the mobile phone. This screen will show any Paired Devices and Available Devices. **Fig. 5, Fig. 6**

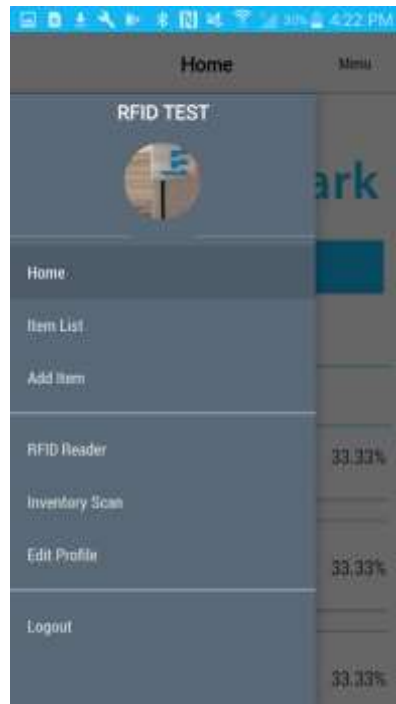

Figure 5

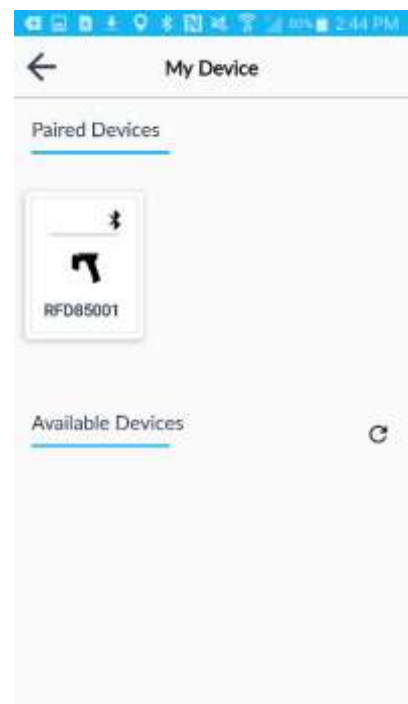

Figure 6

Press on the Bluetooth button on the RFID Reader to pair with the mobile phone.

The RFID Reader will beep, the mobile phone will show that the Reader is connected to the Tracker by showing a bright green Bluetooth icon in the box. **Fig. 7**

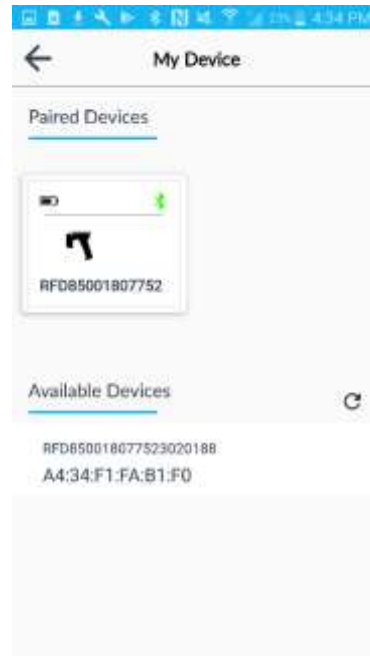

Figure 7

Add Item

To enter the code of the RFID Tray Tag, there are two options:

Option 1-

Tap on Inventory Scan: This will show Scanned Tags. **Fig. 8, Fig. 9**

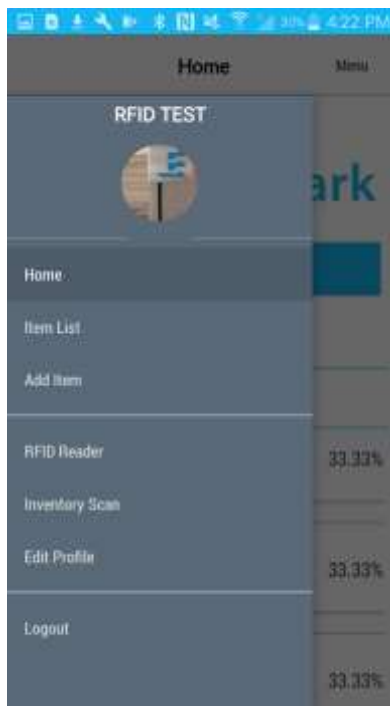

Figure 8

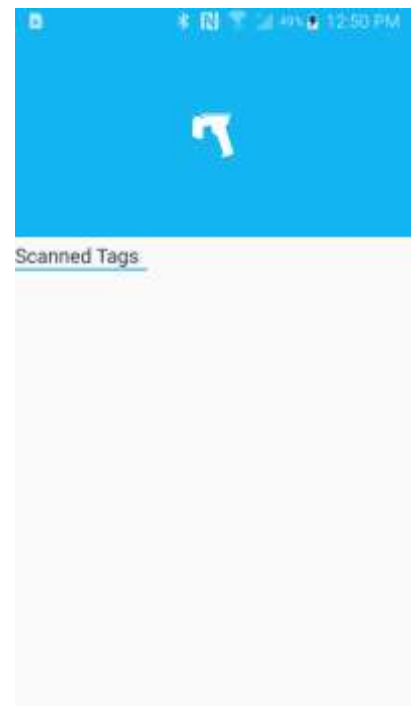

Figure 9

Take the RFID Reader and scan the 26-digit code on the RFID Tray Tag.

- To scan barcodes with the RFID reader: **A unique number is etched onto and automatically programmed to each tray tag.**
- Aim the device at the tray tag to scan in one hand and hold the mobile device in the other to show the bar code that was scanned. **Fig. 10**
- The scan/decode LED lights, and a beep sounds to indicate a successful decode. When scanning the tray tag or item, be sure to point the RFID reader directly at the tray tag.



Figure 10

The top code is the one that was scanned in then tap on COMPLETE SCAN at the bottom of the screen. **Fig. 11**

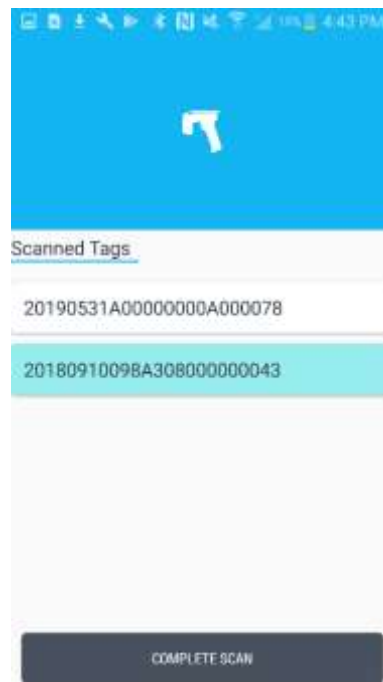

Figure 11

Tap on NEW ASSET and the code will pop up and tap on ADD ITEM. **Fig. 12**

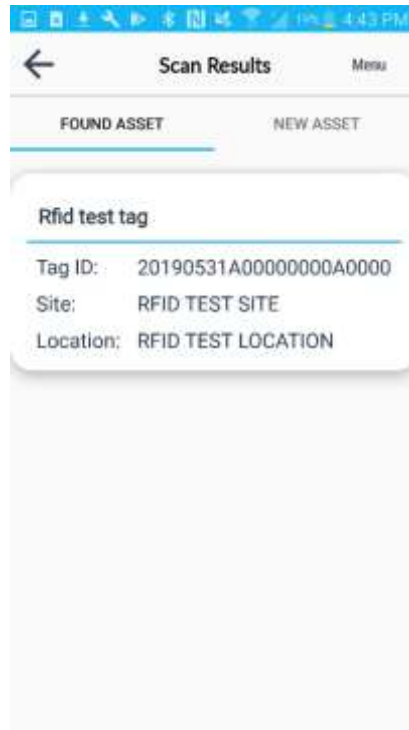

Figure 12

Tap on ADD ITEM. **Fig. 13**

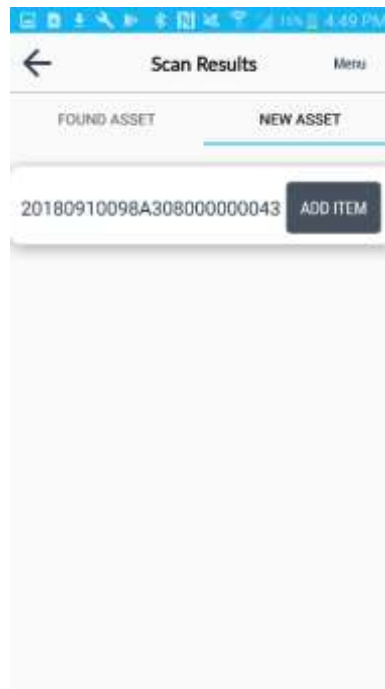

Figure 13

The code will appear in the Asset Tag ID box. **Fig. 14**

Figure 14

Then type in the Item Name, choose from the drop-down arrow for Select Site (where the tray or item is located, Select Core (which core it belongs in), Select Service (surgical service). **Fig. 15**

Figure 15

Tap on Upload Image to take a picture if the tray ID and the picture will be uploaded into the box. Fig. 16 Two options are given if you choose not to use the image that was taken, Change Photo or Delete Photo.

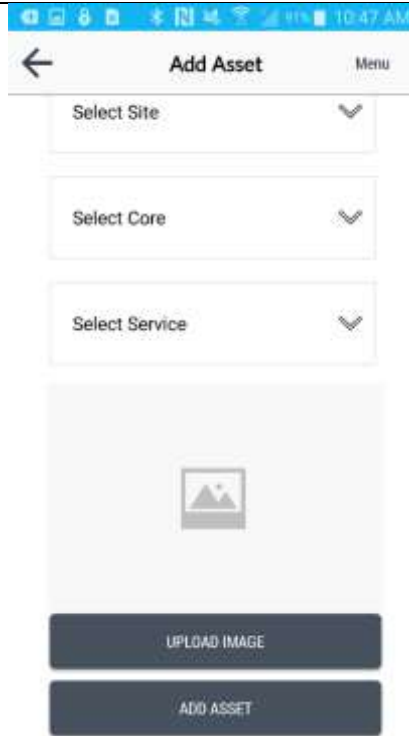

Figure 16

Tap on Add Asset, this will save the Tray Tag ID into inventory. If the tag is already in use on another tray or item a message will appear, “The tag id had already been taken”.

To find the details on a tray or item, tap on Inventory Scan, scan the tray or item, tap on Complete Scan and the Site, Location of where that item or tray is located. **Fig. 17, 18**

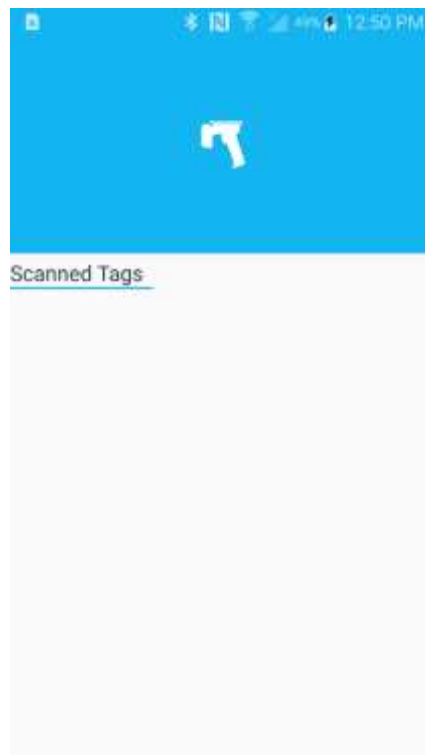

Figure 17



Figure 18

Option 2-

Tap on RFID Reader to pair with the mobile phone. This screen will show any Paired Devices and Available Devices.

Press on the Bluetooth button on the RFID Reader to pair with the mobile phone.

The RFID Read will beep, the mobile phone will show that the Reader is connected to the Tracker by showing a bright green Bluetooth icon in the box.

Tap on the black arrow in the top left corner, tap on Menu.

Tap on Add item.

Type in the 26-digit code. **Fig. 19**

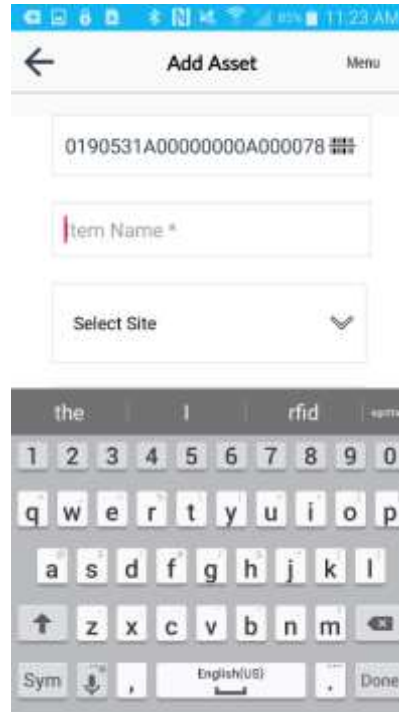

Figure 19

Tap on Select Site (where the tray is located), Select Core (which core it belongs in), Select Service (to indicate what type of surgery it is) from the drop-down arrow. **Fig. 20, Fig. 21**



Figure 20

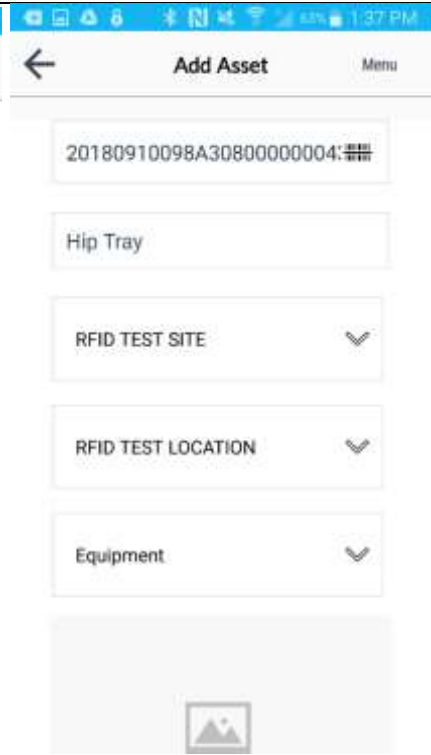

Figure 21

To upload an Image, tap on Upload Image and take a picture of the tag attached to the tray. The image will appear in the box. Fig. 22 Two options are given if you choose not to use the image that was taken, change Photo or Delete Photo.

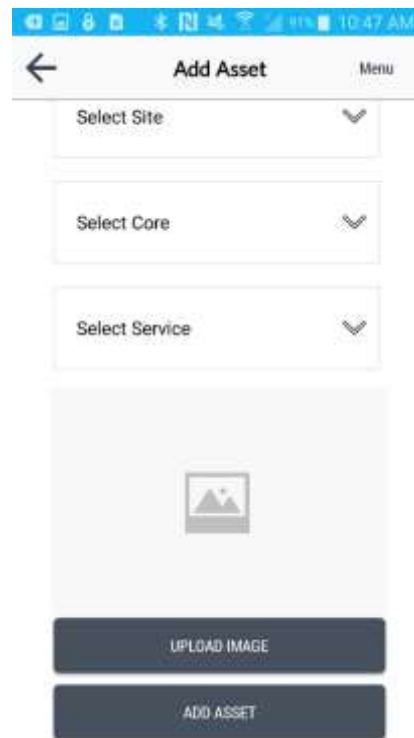

Figure 22

Tap on Add asset, this will save the Tray Tag ID into inventory. If the tag is already in use on another tray or item a message will appear, "The tag id has already been taken".

Item List:

2. To view the list of items in inventory tap on Menu, Item List. This will show the list of the trays and items with the Asset Tag ID. **Fig. 23, Fig. 24**

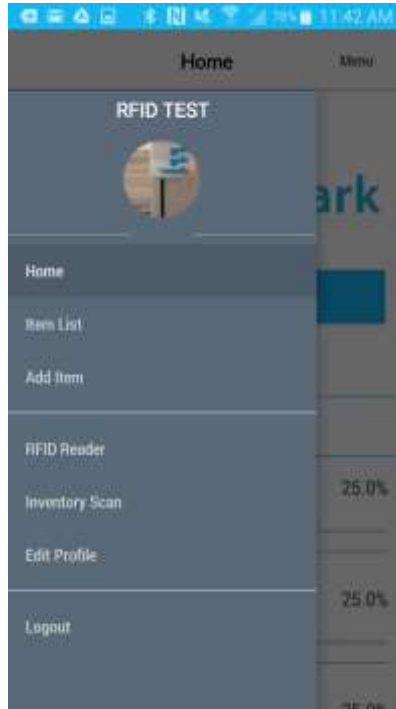

Figure 23

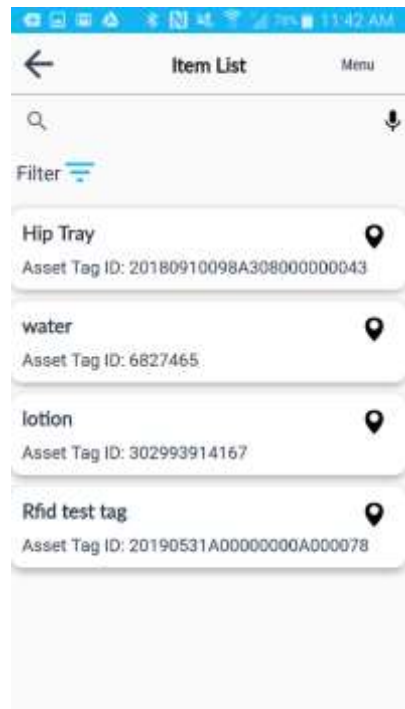

Figure 24

To search for that particular tray or item, tap on the tray or item listed. This will allow the picture, item name, Asset Tag ID, Site, Core and Service. **Fig. 25**

Click on Search Tray. Take the RFID Reader and scan the area for the Asset ID. The RFID Reader will beep faster as you get closer to the tray or item. The blue rectangle will turn blue to indicate how close you are to the tray or item. **Fig. 26, Fig. 27**

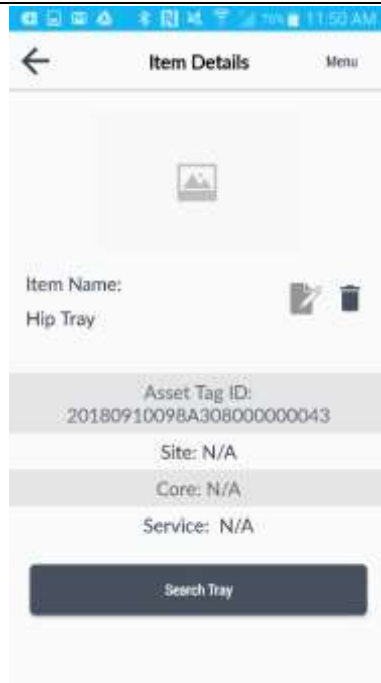

Figure 25

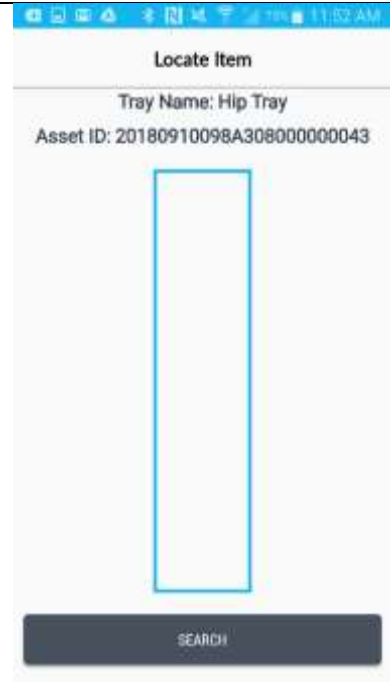

Figure 26

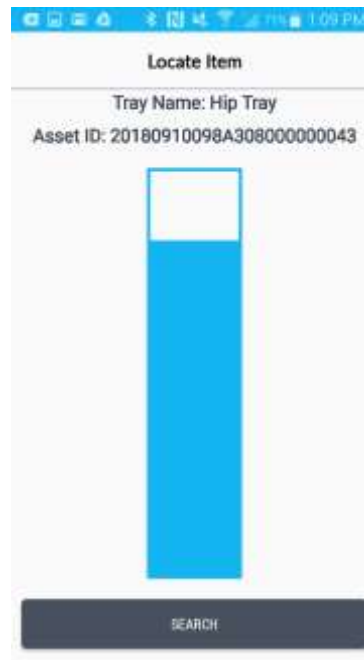

Figure 27

To say the name of the tray or item that you are searching for tap on the microphone icon and say what you want to locate. **Fig. 28**

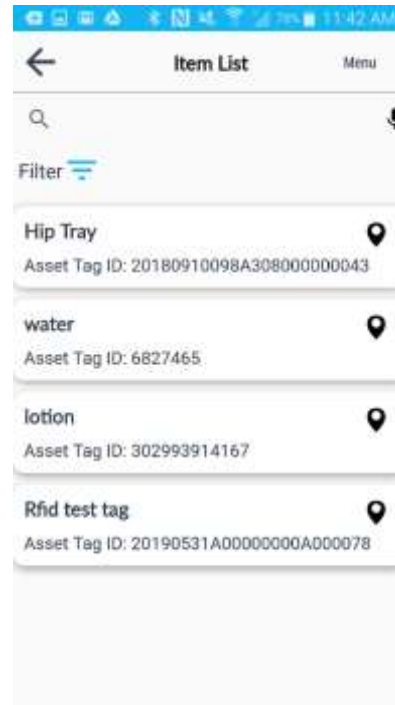

Figure 28

Find Item

3. To find an item or tray tap on Find Item on the home screen. **Fig. 29** Item list is displayed, and this will show the list of the trays and items with the Asset Tag ID. **Fig. 30**



Figure 29

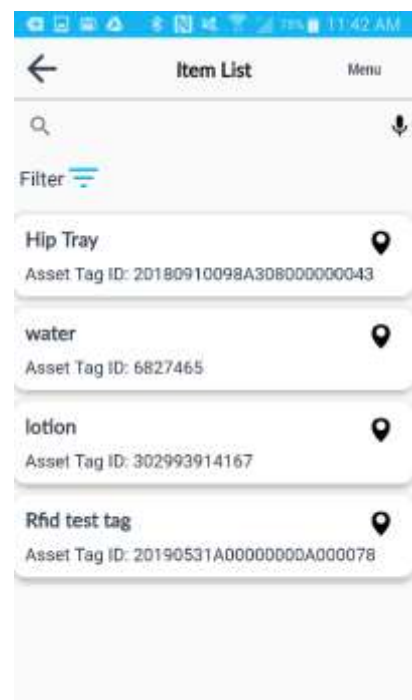

Figure 30

To search for that particular tray or item, tap on the 'location' icon to the right.

- This will show the picture, item name, Asset Tag ID, Site, Core and Service, then click on Search Tray. **Fig. 31**
- Take the RFID Reader and scan the area for the Asset ID. The RFID Reader will beep faster as you get closer to the tray or item. The blue rectangle will turn blue to indicate how close you are to that tray or item. **Fig. 32, Fig. 33**

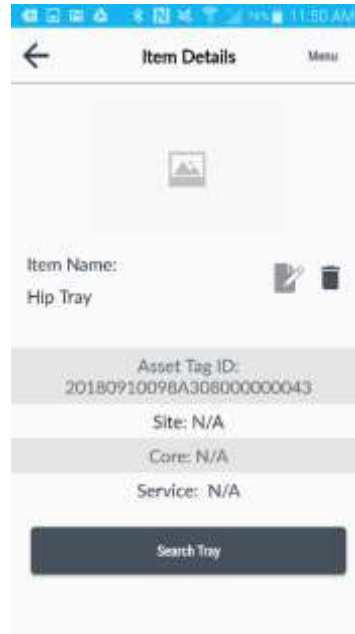

Figure 31

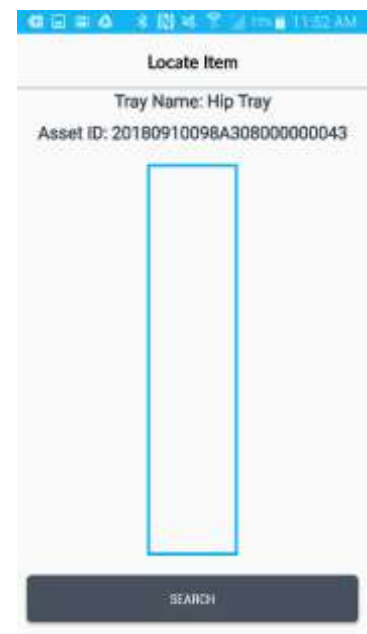

Figure 32

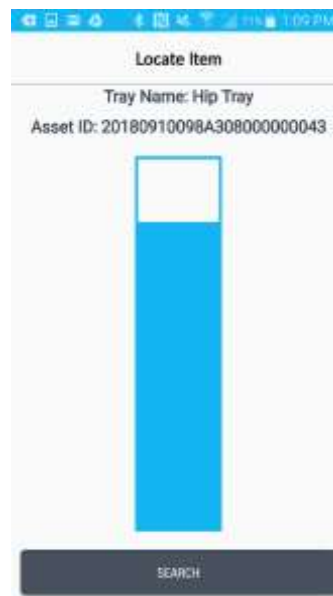

Figure 33

Edit Item

- To edit in item or tray tap Menu on the home screen, tap on Item List, then select from the items listed and tap on the item or tray to be edited. **Fig. 34, Fig. 35**



Figure 34

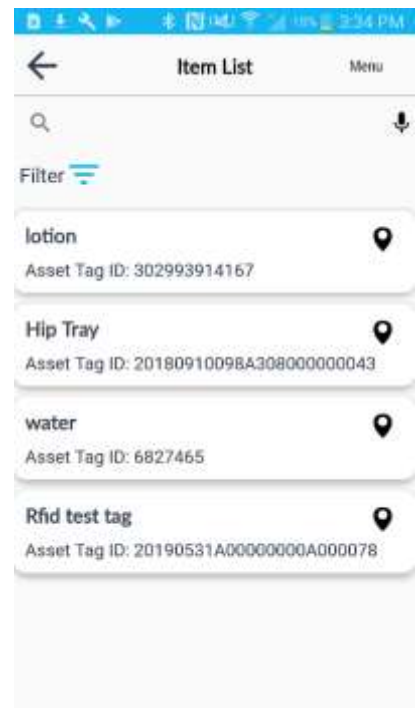

Figure 35

Tap on the pencil icon to the right to edit. Make the necessary changes and tap on UPDATE ASSET at the bottom of the page. **Fig. 36, Fig. 37**

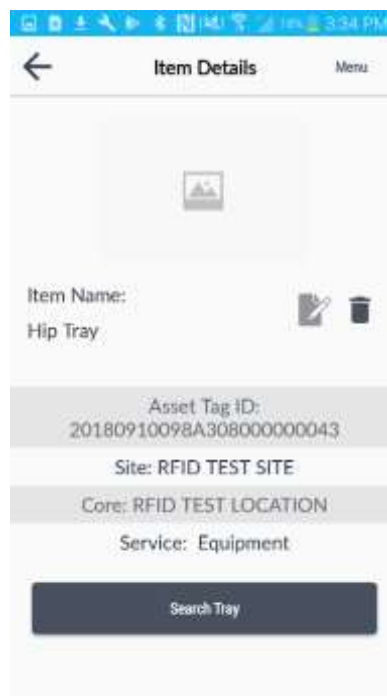

Figure 36

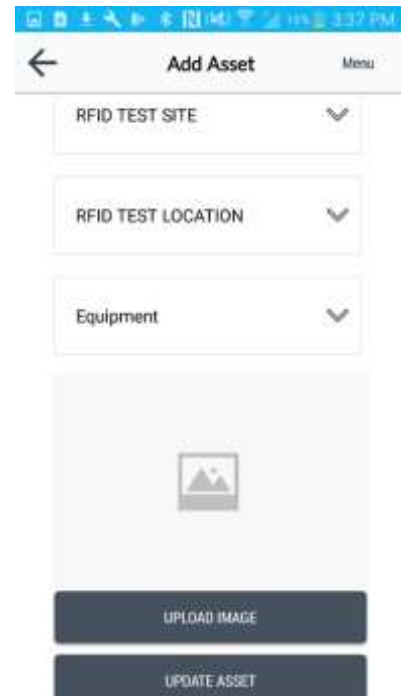

Figure 37

Delete Item

- To delete in item or tray, tap Menu on the home screen, tap Item List, then select from the items listed, then tap on the item or tray to be deleted. **Fig. 38**
- Tap on the trash can icon to the right to delete the item or tray. A message will display, choose CANCEL OR DELETE. By choosing delete this will remove the item or tray from the Item List. **Fig. 39. Fig. 40**

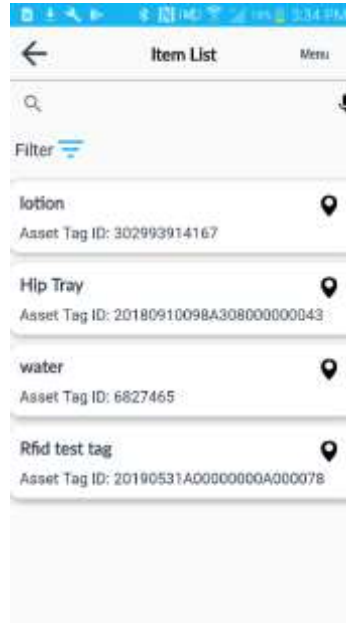

Figure 38

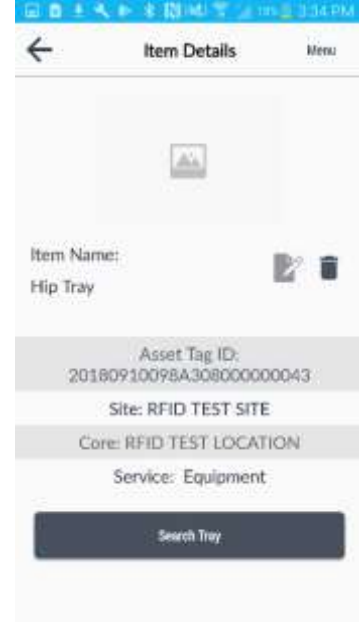

Figure 39

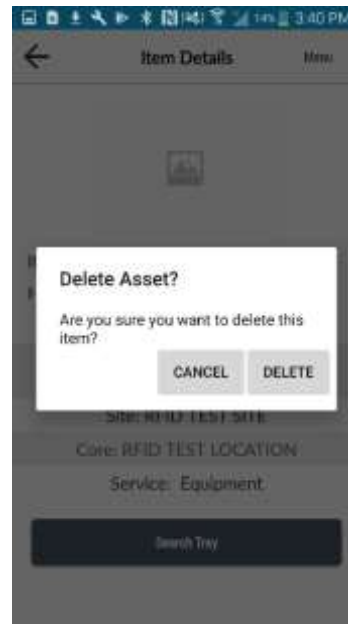

Figure 40

Filter

- To filter what you are searching for tap on Menu, then tap on Filter. **Fig. 41**

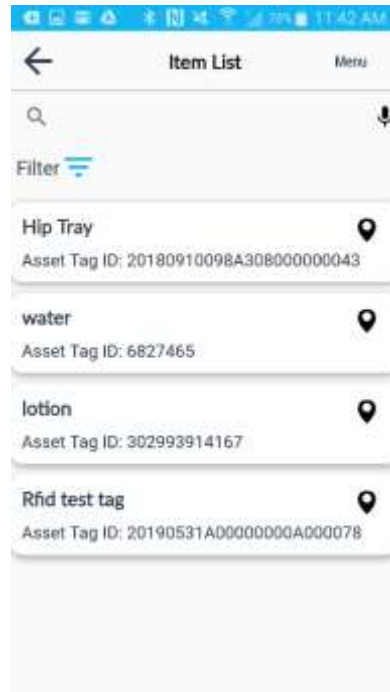

Figure 41

Create Filter allows you to Select Site, Select Core, Select Service from the drop-down list and tap on Apply Filter or Cancel. **Fig. 42**

Once the filter has been created the tray(s) or item(s) are now in its own location. **Fig. 43**

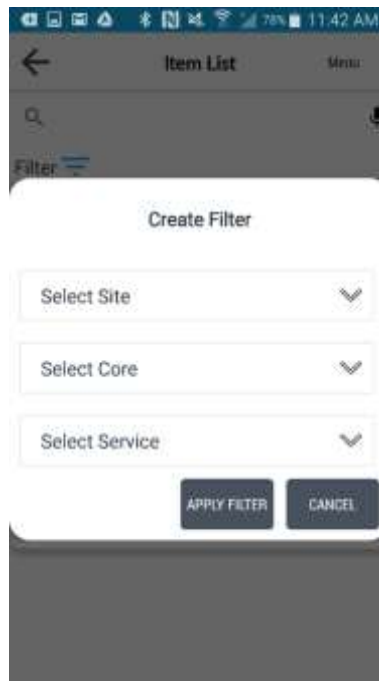

Figure 42

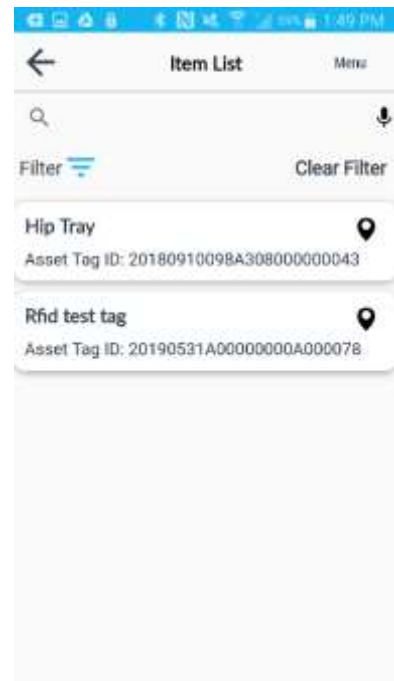

Figure 43

Filter by typing in the search bar

7. Tap on Find Item on the home screen. **Fig. 44** This will take you to the Item List screen.

To filter what you are searching for tap on the search icon located at the top left and type in the item or tray name. Tap the search button at the bottom right corner of the keyboard. **Fig. 45**

A list of what you are searching for will be displayed. **Fig. 46**



Figure 44

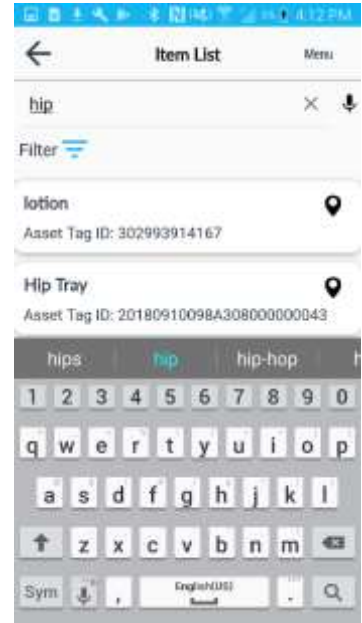

Figure 45

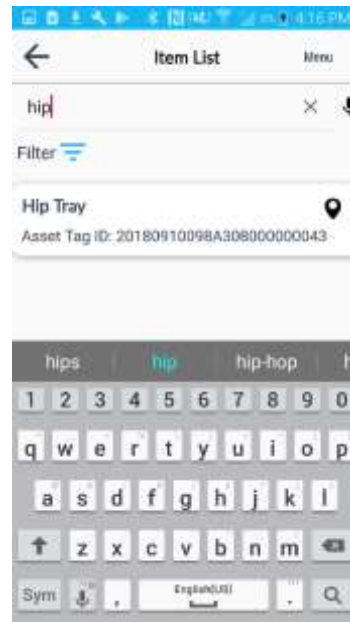

Figure 46

Interpretation of Test Results	N/A
Contraindications of Test Results	N/A
Documentation	N/A

<p>Special Warnings and Cautions</p>	<ul style="list-style-type: none"> • N/AThe RFID tag will not be functional if the tag is left at a maximum indicated temperature such that the internal soak temperature exceeds +80 °C (176 °F). The RFID tag itself will (resume) function between -50 °C to + 80 °C. <p>RFID Reader-</p> <ul style="list-style-type: none"> • Avoid exposing this product with hot oil or other flammable liquids. If such exposure occurs, unplug the device and clean the product immediately in accordance with these guidelines. • When using a can of compressed air, do not point nozzle at yourself and others, ensure the nozzle or tube is pointed away from your face. • Do not store the device with the battery installed. Doing so long term may cause irreversible harm to the battery. Always store the battery removed from the device. If a battery is installed during long term storage, it may discharge to point at which it cannot be recovered. • Even when stored separately from device it is important to follow industry standard guidelines. When batteries are stored for over a year, battery cell manufacturers advise that some irreversible deterioration in overall battery quality may occur. • To minimize this loss, they recommend storing batteries half charged in a dry, cool place between 41° and 77 °F (5 ° and 25 °C), the cooler the better. Batteries should be charged to half capacity at least once a year. • To charge a battery to half capacity, take a fully discharged battery and charge it for two hours. If an electrolyte leakage is observed, avoid any contact with the affected area and properly dispose of the battery.
<p>Disposal</p>	

<p>Reprocessing Instructions</p>	
<p>Point of Use</p>	
<p>Preparation for Decontamination</p>	
<p>Disassembly Instructions</p>	
<p>Cleaning – Manual</p>	<p>Always wear eye protection.</p> <p>100% of the active ingredients in any cleaner must consist of one or some combination of the following for the RFID reader:</p> <ul style="list-style-type: none"> • Isopropyl Alcohol • Bleach/sodium hypochlorite • Hydrogen peroxide or mild dish soap. <ol style="list-style-type: none"> 1. Do not apply liquid directly to the RFID reader. 2. Dampen a soft cloth or use pre-moistened wipes. 3. Do not wrap the device in the cloth or wipe, but gently wipe the unit. 4. Be careful not to let liquid pool around the display window or other places. 5. Allow the unit to air dry before use. 6. Do not clean the device or expose it to rain or moisture when the battery cover is removed. Without the battery cover, the device is not water/dust sealed. <p>Harmful Ingredients:</p> <p>Ammonia solutions, compounds of amines or ammonia; acetone; ketones, ethers; aromatic and chlorinated hydrocarbons; aqueous or alcoholic alkaline solutions; ethanolamine; toluene, trichloroethylene, benzene, carbolic acid and TB-lysoform.</p> <ol style="list-style-type: none"> 7. The RFID reader should not be handled while wearing vinyl gloves containing phthalates, or before hands are washed to remove contaminant residue after gloves are removed. 8. If products containing any of the harmful ingredients listed above are used dry before handling the RFID reader to prevent damage to the plastics. <p>Materials Required-</p> <ul style="list-style-type: none"> • Alcohol wipes • Lens tissue • Cotton tipped applicators • Isopropyl alcohol • Can of compressed air with a tube

	<p>Cleaning RFID Tray Tags-</p> <ol style="list-style-type: none"> 1. Wash tray tags with a neutral pH detergent prior to placing in the automatic washer. <p>Cleaning Charge Connectors-</p> <ol style="list-style-type: none"> 1. Remove the DC power cable from the cradle. 2. Dip the cotton portion of the cotton tipped applicator in Isopropyl Alcohol. 3. Rub the cotton portion of the cotton tipped applicator along the pins of the connector. 4. Slowly move the applicator back-and-forth from one side of the connector to the other. Do not let any cotton residue on the connector. 5. All sides of the connector should also be rubbed with the cotton tipped applicator. 6. Spray compressed air in the connector area by pointing the tube/nozzle about ½ inch away from the surface. 7. Ensure that there is no lint left by the cotton tipped applicator, remove lint if found. 8. IF grease and other dirt can be found on other areas of the cradle, used lint free cloth and alcohol to remove. 9. Allow at least 10 to 30 minutes (depending on ambient temperature and humidity) for the alcohol to air dry before applying power to cradle. 10. If the temperature is low and humidity is high, longer drying time is required. Warm temperature, and dry humidity requires less drying time. 11. Cleaning is up to the customer’s discretion due to the varied environments in which the mobile devices are used. 12. They may be cleaned as frequently as required. However, when used in dirty environments it may be advisable to periodically clean the scanner exit window to ensure optimum scanning performance.
Cleaning – Automated	<p>RFID Tray Tags-</p> <ul style="list-style-type: none"> • Place the RFID Tray Tags in the automatic washer and select the instrument cycle to clean the tag prior to putting into service. Once attached to the instrument tray, can be cleaned in combination with the instrument tray.
Disinfection	N/A
Drying	N/A
Maintenance, Inspection, and Testing	<ul style="list-style-type: none"> • Contact your facility’s technical support if having problems using the equipment. If there is a problem the facility’s technical support will contact Healthmark Customer Service. • Do not expose it to rain or moisture for an extended period of time. • Do not clean the device or expose it to rain or moisture when the battery is removed. Without the battery, the device is not water/dust sealed. • Do not drop the device or subject it to strong impact. • Protect the device from temperature extremes. Do not leave it on the dashboard of a car on a hot day and keep it away from heat sources. • Do not store or use the device in any location that is extremely dusty, damp or wet. • Do not use window cleaning solution. Use a soft cloth dampened with a 50/50 solution of isopropyl alcohol and water. • Do not allow the solution to form a pool of liquid anywhere on the screen or device. • Do not use a large amount of solution to cause the device to remain wet.
Reassembly Instructions	
Packaging	
Sterilization	<p>Tray tag:</p> <ul style="list-style-type: none"> • Steam Sterilization at 270°F (132°C) for 4 minutes and 275°F (135°C) for 3 minutes. • Extended cycle at 275°F (135°C) for 30 minutes.
Storage	<ul style="list-style-type: none"> • Store batteries half charged in a dry, cool place between 41° and 77°F (5° and 25°C). • Do not store the device with the battery installed.
Additional Information	
Related Healthmark Products	

Other Product Support Documents	Labeling Products Brochure, Labeling Products Price List
Reference Documents	N/A
Customer Service Contact	Healthmark Industries Company, Inc 18600 Malyn Blvd. Fraser, MI 48026 1-586-774-7600 healthmark@hmark.com hmark.com

2021-09-17 Suzanne Latta